

# product catalogue

# Contents

About Dimplex	3	<b>Miscellaneous Heating</b>	<b>Water Heating</b>		
EcoDesign (Lot 20)	5	ECOT Tubular Heater	40	QWC Quantum Cylinder	71
Heating Guides	6	MPH Frost Protector	41	QWC Slimline Cylinder	72
<b>Whole House Heating</b>		DXLWP Portable Heater	42	EC-EAU Cylinder	73
Q-Rad Radiator	9	IRX Infra-red Heater	43	<b>Renewable Technologies</b>	
Girona Panel Heater	10	<b>Portable Heating</b>		SmartRad Radiator	74
Monterey Panel Heater	11	DXTT3 Garage Heater	45	Free-E PV Optimiser	75
PLXE Panel Heater	12	OFX / MK1 Oil-filled	46		
PLX Panel Heater	13	Cadiz Eco Oil-free	47	<b>Design Support</b>	
PLXTI/TX Panel Heater	14	OFRC Oil-free	48	Heater Sizing Guide	76
EPX Panel Heater	15	OFC Oil-free	49	Heat Design Request	79
Saletto Panel Heater	16	DXU / DXGLO2 / DXFF	50	Cable Entry Points	83
LST Fan Heater	17	Contrast Convector	51		
Electronic Controls	18	<b>Commercial Heating</b>			
Quantum Off-peak Heater	21	AC Over Door	53		
XLE Storage Heater	22	CAB Air Curtain	54		
DuoHeat Storage Heater	23	DAB Air Curtain	56		
CXLSN Storage Heater	24	IAB Air Curtain	58		
XLS6N Storage Heater	25	ARC Air Curtain	59		
<b>Kitchen &amp; Bathroom Heating</b>		CFH Fan Heater	60		
BPH Bathroom Heater	27	CFH Controller	61		
TDTR Towel Rail	28	CF Fan Heater	62		
CPTS Towel Rail	29	PFH Fan Heater	63		
BR Towel Rail	30	CXD Ceramic Heater	64		
TTR Towel Rail	31	QXD Quartz Heater	65		
S Towel Rail	32	OPH Quartz Heater	66		
LSTS Towel Rail	33	WFC/E Fan Heater	67		
Towel Rail Controllers	34	VFMi Storage Heater	68		
FX20 Downflow Heaters	35	HAW Air Warmer	69		
BFH Plinth Heaters	36				
BUH Plinth Heaters	37				
IP Rating Chart	38				

# About Dimplex®

For nearly 70 years Dimplex has built a portfolio of over 700 affordable and attractively-designed heating solutions that are efficient, reliable and durable. This unrivalled experience, combined with our unmatched reputation for quality and innovation is why we remain the market leader in the electric heating world. We offer products to suit both domestic and commercial applications, across a wide range of categories that are easy to install and readily available from your local wholesaler today.

## Installers, specifiers and end users alike trust Dimplex:

- ✓ The world's largest electric heating appliance manufacturer
- ✓ Award-winning customer services team
- ✓ Our associations include: ECA, EDA, BEAMA and HEVAC
- ✓ We produce BEAB-approved products—the highest safety standard in the UK
- ✓ Maintenance free products available
- ✓ Easy to install, setup and use
- ✓ We offer a free heating design service

For more information contact our team:

Call our pre-sales team: 0800 028 6122

Email: [pre-sales@glendimplex.com](mailto:pre-sales@glendimplex.com)

Visit: [www.dimplex.co.uk](http://www.dimplex.co.uk)

For technical support:

Call: 0844 879 3588

Email: [customer.services@glendimplex.com](mailto:customer.services@glendimplex.com)

Visit: [www.dimplex.co.uk/support](http://www.dimplex.co.uk/support)



# A Name You Can Trust

We are proud of our long-standing relationship with the trade and our tradition of developing bespoke heating solutions for your customers, providing great value for money, impressive reliability and outstanding customer service.

## Our products, your benefits.



### Tried and tested technology.

All Dimplex products are designed to meet the latest international performance and safety standards. They are subjected to rigorous testing and evaluation using state-of-the-art facilities that recreate challenging environments to ensure our products perform – every time.



### Standard Assessment Procedure (SAP).

Dimplex offers electric heating solutions that can make gaining SAP compliance in multiple dwellings easier than you might think. For example the Dimplex Quantum could improve a properties SAP rating by as much as ten points.



### Customer service.

When you choose Dimplex, you have the support of our experienced award winning customer service team, as well as backup provided by our national network of specialist service engineers.



### Free design service.

Our in-house design team can provide detailed plans for the application of our technologies which are specific to an individual property. These include full heat loss calculations, energy saving estimates, plus a complete product and accessory specification.



### Wide distribution network.

Our wide distribution network utilises our national and regional partners to ensure full product availability through national and independent distributors.



### Product warranty\*

For extra peace of mind, Dimplex offers comprehensive product warranties to ensure continued performance and protection against manufacturing defects. Dimplex Quantum has a 10 year warranty and all EC-Eau cylinders have a 25-year guarantee for the inner cylinder.

\* Terms and conditions apply.

# Ecodesign Regulations and Electric Heating

Electric heating is changing, and just like light bulbs and gas boilers, new regulations are redefining the technology that can be sold in the UK.

Here's what you need to know about these upcoming changes:

## What is the Ecodesign Directive?

The Ecodesign Directive sets minimum specification requirements for products that consume energy. It aims to deliver more energy efficient products and reduce their energy consumption.

## How does it work?

It provides requirements that products must meet if they are to continue to be sold. This means that manufacturers must either update their products to comply with the new regulations, or discontinue them and replace with more efficient technologies.

## What is Lot 20?

Lot 20 is the section of Ecodesign that deals specifically with electric heating.

## When will it start?

From the 1st January 2018, electric space heating products manufactured for sale in the UK will have to comply with a new minimum efficiency rating for their category.

## Which products are affected?

The legislation affects the following, and there are different requirements for each category:

- Storage heating
- Direct acting heating (panel heaters and electric radiators)
- Portable heating
- Infra-red heating

The Dimplex Quantum, Q-Rad Electric Radiator, Bathroom Panel Heater and Low Surface Temperature Heater already comply with these new requirements. Look for the 'Ecodesign Compliant' logo on the pages of this brochure and visit [www.lot20.co.uk](http://www.lot20.co.uk) for more information.



## How does this affect you?

Lot 20 will affect everyone manufacturing and selling electric heating products into the UK. Non-compliant products will no longer be manufactured from the date above, but can still be sold after that date until they are cleared through the market. This means that you will need to change the products that you buy, install and recommend as the new regulations come into the market.

## For more information on this subject please contact:

Email: [pre-sales@glendimplex.com](mailto:pre-sales@glendimplex.com)

Call: 0800 028 6122

Visit: [www.dimplex.co.uk](http://www.dimplex.co.uk)

## Domestic Heating Guide

Airing Cupboard	Pages	Ensuite	Pages	Main Bedrooms	Pages
Coldwatcher	41	Q-Rad radiator	9	Q-Rad radiator	9
Tubular heaters	40	Panel heaters	10-17	Panel heaters	10-17
		Fan heaters	35	DuoHeat radiator	23
Attic Conversion		Towel rails	28-33		
Panel heaters	10-17			Patio	
Q-Rad radiator	9	Greenhouse		Quartz heaters	64 - 66
Convactor heaters	51	Coldwatcher	41		
Portable standing heaters	45-51	Tubular heaters	40	Spare Bedroom	
Slimline heaters	42			Panel heaters	10-17
		Hallway / Landing		Q-Rad radiator	9
Bathroom		Quantum off-peak heater	21	Convactor heaters	51
Q-Rad radiator	9	DuoHeat radiator	23	Portable standing heaters	45-51
Panel heaters	10-17	Q-Rad radiator	9	Slimline heaters	42
DuoHeat radiator	23	Panel heaters	10-17		
Fan heaters	35	Storage heaters	22-25	Study	
Towel rails	28-33			Quantum off-peak heater	21
Bathroom panel heaters	27, 38	Kitchen		DuoHeat radiator	23
IRX	43	Downflow heaters	35	Q-Rad radiator	9
		Base unit heaters	36-37	Panel heaters	10-17
Conservatory		Quantum off-peak heater	21	Storage heaters	22-25
Q-Rad radiator	9	Towel rails	28-33	Convactor heaters	51
Panel heaters	10-17	Q-Rad radiator	9	Portable standing heaters	45-51
Convactor heaters	51	Panel heaters	10-17	Slimline heaters	42
Portable standing heaters	45-51	Storage heaters	22-25		
Slimline heaters	42			Utility Room	
		Lounge		Panel heaters	10-17
Dining Room		Quantum off-peak heater	21	Base unit heaters	36-37
Quantum off-peak heater	21	Q-Rad radiator	9	Fan heaters	35
DuoHeat radiator	23	DuoHeat radiator	23	Towel rails	28-33
Q-Rad radiator	9	Panel heaters	10-17		
Panel heaters	10-17	Storage heaters	22-25	Workshop	
Storage heaters	22-25			Portable fan heaters	50
				Multi-purpose heaters	41, 51
				Quartz heaters	65

Care Facilities	Pages	Public Buildings	Pages
LST panel heaters	17	<i>(Churches, Libraries, Museums)</i>	
LST towel rails	33	Over door heaters	53
		Air curtains	54-56
		Compact fan heaters	63
		Wall fan convectors	67
		VFMi	68
		Quartz radiant / ceramic	64-65
		Panel / electric heaters	9-17
Hospitality		Retail / Offices	
<i>(Hotel, Restaurant, Leisure)</i>		Over door heaters	53
Patio heaters	64-66	Air curtains	54-56
Panel / electric heaters	9-17	Architectural air curtains	59
Air curtains	54-56	Compact fan heaters	63
Quartz radiant / ceramic	64-65	Panel / electric radiators	9-17
Towel rails	28-33	Wall fan convectors	67
VFMi	68	Patio heaters	64-66
Wall fan convectors	67		
		Other	
		Convector heaters	51
		Portable heating	50
Industrial			
Air curtains	58		
Fan heaters	60-62		
Quartz radiant / ceramic	64-65		
Air warmers	69		
Large Commercial			
<i>(Airports, Hospitals)</i>			
Air curtains	54-56		
Architectural air curtains	59		
Wall fan convectors	67		
Fan heaters	60-62		
VFMi	68		
Quartz radiant / ceramic	64-65		

# Whole House Heating







## Installation

Supplied with metal wall bracket.

## IP Rating

IPX4.

## Cable Entry Point

Bottom right. 1m cable length.

## Thermal Cut-out

Two auto reset cut-outs, one for each element. Thermal fuse protection on front element.

## Element

Radiant: Encapsulated radiant element fixed to the inside of the front panel, covering the whole fascia.

Convector: Compact, finned, mineral-filled sheathed type, providing silent operation.



## Construction

Durable epoxy-polyester powder coated steel casing, with upward facing grille. Temperature resistant nylon thermoplastic moulded parts.

## Controls

Lot 20 compliant with electronic seven day time and temperature.

## Colour

White.

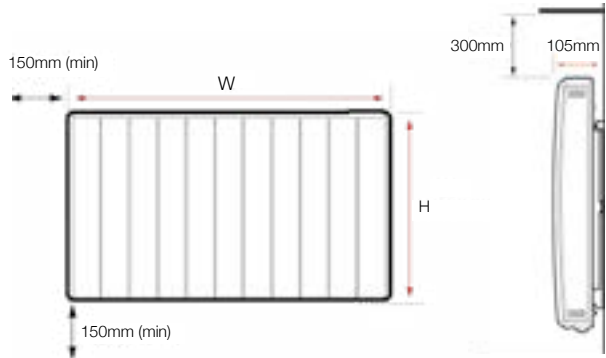

Model	Output (kW)	Convective (W)	Radiant (W)	Height (mm)	Width (mm)	Depth (mm)	Weight (kg)
QRAD050	0.5	301	199	546	513	105	7.1
QRAD075	0.75	551	199	546	513	105	7.1
QRAD100	1.0	714	286	546	675	105	8.7
QRAD150	1.5	1213	287	546	756	105	9.4
QRAD200	2.0	1660	340	546	918	105	11.0

# Girona

Panel Heater



**EcoDesign Compliant**  
www.tst20.co.uk

EcoDesign compliant version available spring 2018. (E)



Intertek



## Installation

Supplied with metal wall bracket.

## IP Rating

IPX4.

## Cable Entry Point

Bottom right. 1m cable length.

## Thermal Cut-out

Auto-reset type.

## Element

Compact, finned, mineral-filled sheathed type, providing virtually silent operation.

## Construction

Durable epoxy-polyester powder coated steel casing, with upward facing grille. Temperature resistant nylon thermoplastic moulded parts.

## Controls

Electronic thermostat with choice of plug in modules (page 18).

## Colour

White / Black.

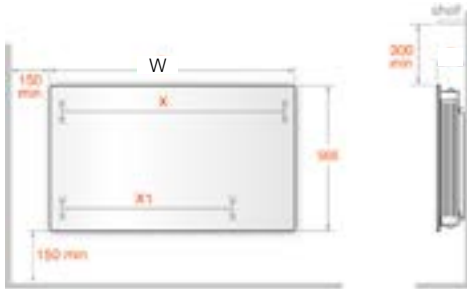

Model	Output (kW)	Height (mm)	Width (mm)	Depth (mm)	X (mm)	X1 (mm)	Weight (kg)
GFP050W(E)	0.5	565	530	107	390	168.5	13
GFP075W(E)	0.75	565	530	107	390	168.5	13
GFP100W(E)	1	565	700	107	560	338.5	16.5
GFP150W(E)	1.5	565	770	107	630	408.5	20
GFP200W(E)	2	565	940	107	800	578.5	26
GFP050B(E)	0.5	565	530	107	390	168.5	13
GFP075B(E)	0.75	565	530	107	390	168.5	13
GFP700B(E)	1	565	700	107	560	338.5	16.5
GFP150B(E)	1.5	565	770	107	630	408.5	20
GFP200B(E)	2	565	940	107	800	578.5	26

# Monterey

Panel Heater

## Installation

Supplied with metal wall bracket.

## IP Rating

IPX4.

## Cable Entry Point

Bottom right. 1m cable length.

## Thermal Cut-out

Auto-reset type.

## Element

Compact, finned, mineral-filled sheathed type, providing virtually silent operation.

## Construction

Durable epoxy-polyester powder coated steel casing, toughened safety glass with upward facing grille. Temperature resistant nylon thermoplastic moulded parts.

## Controls

Electronic thermostat with choice of plug in modules (page 18).

## Colour

White.

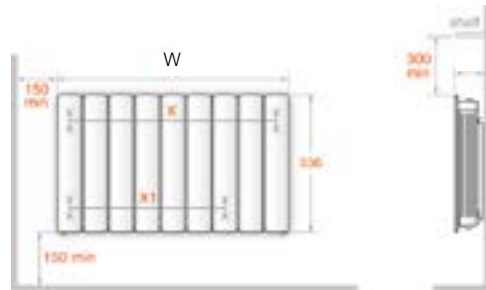

Model	Output (kW)	Height (mm)	Width (mm)	Depth (mm)	X (mm)	X1 (mm)	Weight (kg)
MFP050W(E)	0.5	536	503	104	390	168.5	12
MPF075W(E)	0.75	536	503	104	390	168.5	12
MFP100W(E)	1	536	671	104	560	338.5	15
MFP150W(E)	1.5	536	741	104	630	408.5	17.5
MFP200W(E)	2	536	911	104	800	578.5	22

# PLXE

Panel Heater



## Installation

Detachable wall-mounting 'H' bracket.

## IP Rating

IPX4.

## Cable Entry Point

Bottom right. 1m cable length.

## Thermal Cut-out

Auto-reset type.

## Element

Compact, finned, mineral-filled sheathed type, providing virtually silent operation.

## Construction

Durable epoxy-polyester powder coated steel casing, with forward facing grille. Temperature resistant PBT thermoplastic moulded parts.

## Controls

Lot 20 compliant with electronic seven day time and temperature.

## Colour

White.

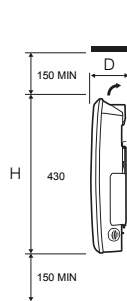
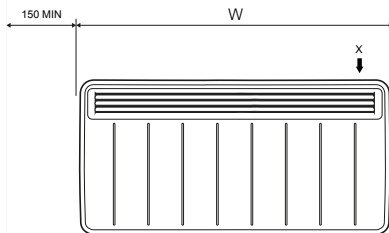

Model	Output (kW)	Height (mm)	Width (mm)	Depth (mm)	Weight (kg)
PLX050E	0.5	430	450	108	4.6
PLX075E	0.75	430	620	108	5.9
PLX100E	1	430	620	108	5.9
PLX125E	1.25	430	690	108	6.1
PLX150E	1.5	430	690	108	6.1
PLX200E	2	430	860	108	7.8
PLX300E	3	430	860	143	8.7

# PLX

Panel Heater



## Installation

Detachable wall-mounting 'H' bracket.

## IP Rating

IPX4.

## Cable Entry Point

Bottom right. 1m cable length.

## Thermal Cut-out

Auto-reset type.

## Element

Compact, finned, mineral-filled sheathed type, providing virtually silent operation.

## Construction

Durable epoxy-polyester powder coated steel casing, with forward facing grille. Temperature resistant PBT thermoplastic moulded parts.

## Controls

Mechanical thermostat

\*For 'no controls' add NC to model ref.

## Colour

White.



This product is not Lot 20 compliant.  
Replacement model PLXE on page 12.

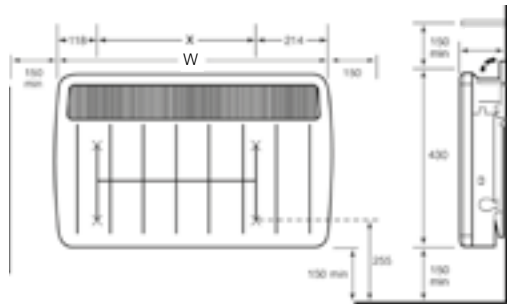

Model*	Output (kW)	Height (mm)	Width (mm)	Depth (mm)	X (mm)	Weight (kg)
PLX500	0.5	430	450	108	117	4.8
PLX750	0.75	430	620	108	287	6.2
PLX1000	1	430	620	108	287	6.2
PLX1250	1.25	430	690	108	355	6.6
PLX1500	1.5	430	690	108	355	6.6
PLX2000	2	430	860	108	527	8
PLX3000	3	430	860	143	527	10

# PLXTI

Panel Heater



Intertek



This product is not Lot 20 compliant.  
Replacement model PLXE on page 12.

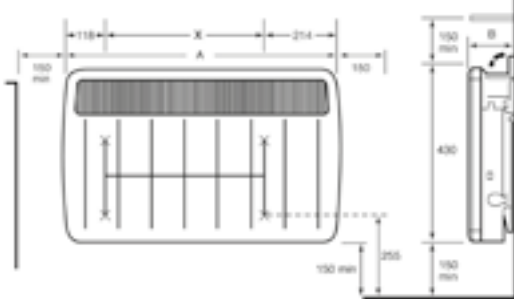

## Installation

Detachable wall-mounting 'H' bracket.

## IP Rating

IPX4.

## Cable Entry Point

Bottom right. 1.2m cable length.

## Thermal Cut-out

Auto-reset type.

## Element

Compact, finned, mineral-filled sheathed type, providing virtually silent operation.

## Construction

Durable epoxy-polyester powder coated steel casing, with forward facing grille. Temperature resistant PBT thermoplastic moulded parts.

## Controls

24-hour timer.

## Colour

White.

Model*	Output (kW)	Height (mm)	Width (mm)	Depth (mm)	X (mm)	Weight (kg)
PLX500TI	0.5	430	450	108	117	4.8
PLX750TI	0.75	430	620	108	287	6.2
PLX1000TI	1	430	620	108	287	6.2
PLX1250TI	1.25	430	690	108	355	6.6
PLX1500TI	1.5	430	690	108	355	6.6
PLX2000TI	2	430	860	108	527	8
PLX3000TI	3	430	860	143	527	10

# EPX

Panel Heater



This product is not Lot 20 compliant.  
Replacement model PLXE on page 12.

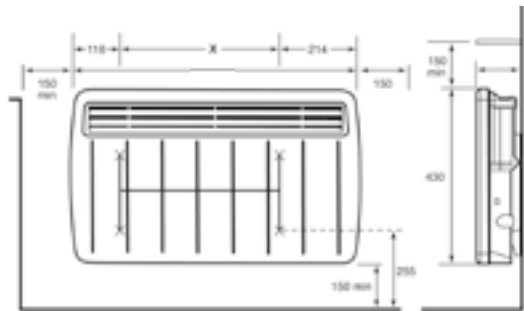

## Installation

Detachable wall-mounting 'H' bracket.

## IP Rating

IPX4.

## Cable Entry Point

Bottom right. 1.2m cable length.

## Thermal Cut-out

Auto-reset type.

## Element

Compact, finned, mineral-filled sheathed type, providing virtually silent operation.

## Construction

Durable epoxy-polyester powder coated steel casing, with forward facing grille. Temperature resistant PBT thermoplastic moulded parts.

## Controls

Electronic thermostat with choice of plug in modules (page 18).

## Colour

White.

Model	Output (kW)	Height (mm)	Width (mm)	Depth (mm)	X (mm)	Weight (kg)
EPX500	0.5	430	450	108	117	5.2
EPX750	0.75	430	620	108	287	6.6
EPX1000	1	430	620	108	287	6.6
EPX1250	1.25	430	690	108	355	7.1
EPX1500	1.5	430	690	108	355	7.1
EPX2000	2	430	860	108	527	8.5

# Saletto

Low Profile Panel Heater

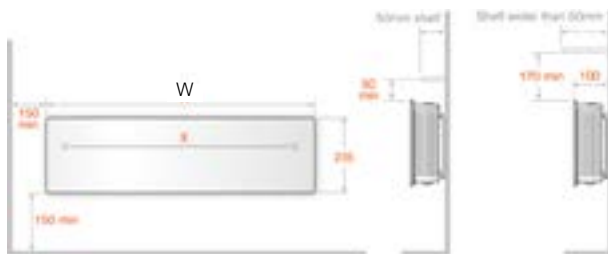

## Installation

Supplied with metal wall bracket.

## IP Rating

IPX4.

## Cable Entry Point

Bottom right. 1m cable length.

## Thermal Cut-out

Auto-reset type.

## Element

Compact, finned, mineral-filled sheathed type, providing virtually silent operation.

## Construction

Durable epoxy-polyester powder coated steel finish. Temperature resistant nylon thermoplastic moulded parts.

## Controls

Electronic thermostat with choice of plug in modules (page 18).

## Colour

White.

Model	Output (kW)	Height (mm)	Width (mm)	Depth (mm)	X (mm)	Weight (kg)
LPP050	0.5	235	746	100	671	6.7
LPP075	0.75	235	746	100	671	6.7
LPP100	1	235	877	100	802	7.6
LPP150	1.5	235	1142	100	1067	9.9



LST

Low Surface Temperature Panel Heater

### Installation

Supplied with metal wall 'H' bracket.

### IP rating

IP24.

### Cable Entry Point

Bottom right. 1m cable length.

### Thermal Cut-out

Two auto reset cut-outs.

### Element

Compact, finned, mineral-filled sheathed type. Fan assisted.

### Construction

Durable epoxy-polyester powder coated steel casing, with outward facing grille. Temperature resistant nylon thermoplastic moulded parts.

### Controls

Lot 20 compliant with electronic seven day time and temperature.

### Colour

White.



Designed to comply with the maximum surface temperature requirements of 43°C as recommended by NHS estates health guidance notes.

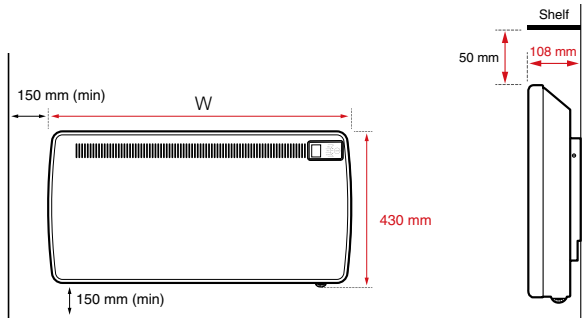

Model	Output (kW)	Height (mm)	Width (mm)	Depth (mm)	Weight (kg)
LST050	0.5	430	688	108	7.1
LST075	0.75	430	688	108	7.1
LST100	1	430	688	108	8.7
LST150	1.5	430	860	108	9.4

Choose the functionality you require from the first column, then check that the unit fits your product and specification needs.

Control requirement	Model		Signalling method
24-hour control over one heater	Programmable 24-hour digital timer <b>RX24TI (White)</b> <b>RX24TIB (Black)</b>		Single heater
Runback timer for one heater	Electronic runback timer <b>RXRBTI (White)</b> <b>RXRBTIB (Black)</b>		Single heater
Seven-day control over one or multiple heaters	Single zone programming cassette <b>RXPW1</b>		Pilot wire
Multi-zone control from a wall-mounted programmer	4-zone wall-mounted programmers <b>RXPW4N</b>		Pilot wire
Running a towel rail or water cylinder from a wall mounted control	Pilot wire interface <b>RXPWIF</b>		Pilot wire
Push switch and PIR occupancy sensors	PX range <b>PX01001</b> <b>PXP700</b> <b>PX9900</b>		Mains

Product features	Compatibility
<ul style="list-style-type: none"> <li>Plugs directly into panel heater</li> <li>Four programmable time periods</li> <li>Programme advance and manual override features</li> <li>Removable cassette</li> <li>Back-lit LCD with power save mode</li> <li>12 hour memory save in event of power failure</li> </ul>	<p>Monterey Girona Saletto EPX</p>
<ul style="list-style-type: none"> <li>Allows heater to operate only for a pre-set period of time</li> <li>Installer adjustable runback timers, 30 mins to 4 hours</li> <li>Can be locked into heater</li> <li>Neon indicator when time period is active</li> <li>Alternative 'advanced' model allows heater to be controlled on comfort/background basis</li> </ul>	<p>Monterey Girona Saletto EPX</p>
<ul style="list-style-type: none"> <li>Seven-day, single-zone pilot wire programming cassette – plugs directly into heater</li> <li>Master/slave control – master heater fitted with programmer controls up to 10 slave heaters</li> <li>Four programmable time periods for weekdays and weekends</li> <li>Programme advance and manual override features</li> <li>Removable cassette</li> <li>Back-lit LCD with power save mode</li> <li>12 hour memory save in event of power failure</li> </ul>	<p>Monterey Girona Saletto EPX</p>
<ul style="list-style-type: none"> <li>Wall-mounted, mains powered unit</li> <li>Installer option to allow switching between comfort/setback, comfort/off or comfort/frost protection modes</li> <li>Manual programme override facility with automatic return to programme at next times charge</li> <li>Continuous comfort, setback, frost protection and off modes</li> <li>Holiday (time absence) mode</li> </ul>	<p>LST, Monterey, Girona, Saletto, EPX and DuoHeat</p>
<ul style="list-style-type: none"> <li>Allows control over ancillary appliances up to 3kW (16A) load</li> <li>Installed local to appliance being controlled – 38mm single gang wiring accessory back box required (not supplied)</li> <li>Switches power to appliance when programmer in comfort mode; disconnects supply when programmer in all other modes</li> <li>Ideal for use with the RXPW4N four-zone pilot wire programmer</li> </ul>	<p>Towel rails and hot water immersion heater cylinder rated up to 3kW (16A) load</p>
<ul style="list-style-type: none"> <li>Ideal to control energy costs in areas such as student accommodation, hotels and offices</li> <li>Designed for use with the PLX/NC no control panel heaters or any other heaters up to 3kW output (except Quartz)</li> <li>When activated, room temperature is boosted from background to comfort temperature for a pre-set time period</li> <li>Comfort temperature, background temperature and time delay selected on installation – user can't adjust settings once installed</li> <li>PX1001 touchpad activated</li> <li>PX9700 &amp; PX9900 activated by PIR occupancy detector</li> <li>PX9900 offers additional level of setback (fixed at 5°C if room is unoccupied after 8 hours)</li> </ul>	<p>Monterey Girona Saletto EPX</p>

### Types of Electric Heater

Many people are still unclear as to the types of electric heating system available, and the meters and tariffs that they use. There are two basic technology types, direct-acting heating and storage heating.

To avoid recommending the wrong type of heater for a property it is important to understand the basic operation of these two technologies. For example, changing an old storage heater to a direct-acting heater could significantly increase the cost of heating that room, and if the meter were also changed from dual to single-rate the cost of the whole properties hot water and night-time appliance use would also go up.

### Direct Acting

Direct-acting heaters use peak-rate electricity to heat a space. These are also known as panel heaters, electric radiators, aluminium radiators or oil-filled radiators, depending on the technology used to house the element. These heaters are all 100% efficient at the point of use and will cost the same amount to run, as they convert peak-rate electricity into heat when it is needed, through a single-rate electric meter.

The heaters prior to this page in the 'Whole House Heating' section are all direct-acting heaters. These units are perfect for new-build and well-insulated properties, or rooms that have low or occasional requirements for use such as bedrooms, studies and light commercial spaces. They are also ideal for use within a building that does not have a dual-rate (off-peak) electric meter.

### Storage Heating

Storage heaters use off-peak energy (costing around half that of peak-rate energy per kW) to heat a space. These heaters take energy in at night and store it ready for use the next day. Storage heaters are cheaper to operate than direct-acting heaters because they use energy taken in during the off-peak (cheaper) periods. They can do this because of a dual-rate electric meter, which provides electricity at two rates/prices (peak and off-peak). This often means that the hot water needs of the property are met using cheaper electricity, as well as any appliances that are used during these off-peak times.

### High Heat Retention Storage Heating (HHRSH)

The modern replacement option for traditional storage heaters, high-heat retention storage heaters use the latest technology to store heat for longer and release it only when it's needed.

High Heat Retention Storage Heaters are the cheapest way to heat a room electrically for 24hrs, and replacing traditional storage heaters with HHRSH units in a property will improve the EPC rating, running cost, comfort and control offered by the system.

**QUANTUM**  
heating system  
Off-peak Heater

**Installation**

Floor standing and fixed to wall via wall fixing bracket.

**IP Rating**

IPX2 - QM050 soon to be IPX4.

**Cable Entry Point**

Dual entry, both sides bottom right. No cable supplied.

**Thermal Cut-out**

Electromechanical.

**Elements**

Incoloy sheathed.

**Construction**

High density bonded magnetite energy cells surrounded with microporous silica and calcium silicate slab insulation all enclosed in an attractive case.

**Controls**

Lot 20 compliant with electronic seven day time and temperature.

**Colour**

White.

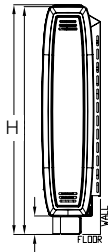
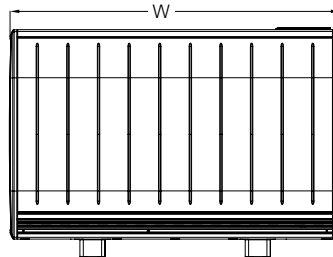
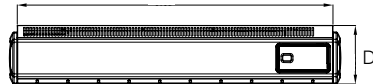

Model	Input (kW)	Output (kW)	Boost (kW)	Height (mm)	Width (mm)	Depth (mm)	Weight (kg)	Installed weight (kg)	Energy pack requirement
QM050	1.1	0.5	0.4	730	580	185	27.2	66	4
QM070	1.56	0.7	0.63	730	703	185	24.8	83	6
QM100	2.2	1.0	0.88	730	865	185	29.4	107	8
QM125	2.76	1.25	1.13	730	1069	185	38	135	10
QM150	3.3	1.5	1.3	730	1069	185	38.6	155	12

A tall feet kit (QFEET) is available to take skirting board clearance from 28mm x 123mm to 28mm x 203mm

# XLE

Storage Heater



Intertek

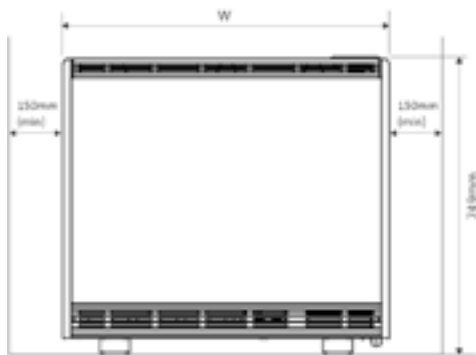

## Installation

Floor standing and fixed to wall via wall fixing bracket.

## IP Rating

IPX2.

## Cable Entry Point

Dual entry, both sides bottom right. No cable supplied.

## Thermal Cut-out

Electromechanical.

## Elements

Incoloy sheathed.

## Construction

High density bonded magnetite energy cells insulated with microtherm on back front and top.

## Controls

Lot 20 compliant with electronic seven day time and temperature.

## Colour

White.

Model	Input (kW)	Output (kW)	Height (mm)	Width (mm)	Depth (mm)	Weight (kg)	Max. Storage capacity (kWh)
XLE050	1.02	0.5	749	580	185	65	7.14
XLE070	1.56	0.5	749	700	185	87	10.92
XLE100	2.22	1	749	723	185	109	15.54
XLE125	2.76	1.25	749	945	185	135	19.32
XLE150	3.3	1.5	749	1067	185	157	23.1



### Installation

Floor standing and fixed to wall via wall fixing bracket.

### Cable Entry Point

Bottom right. 1.6m cable length.

### Thermal Cut-out

Auto-reset type.

### Elements

Incoloy sheathed in units of 650W. Encapsulated microwire element (front panel).

### Construction

Durable polyester coated steel front and rear casing, mounted on plastic feet. Insulated heat-retaining core behind inner front skin.

### Controls

Electronic thermostat.

### Colour

White.



Intertek

This product is not Lot 20 compliant. Replacement model XLE on page 22.

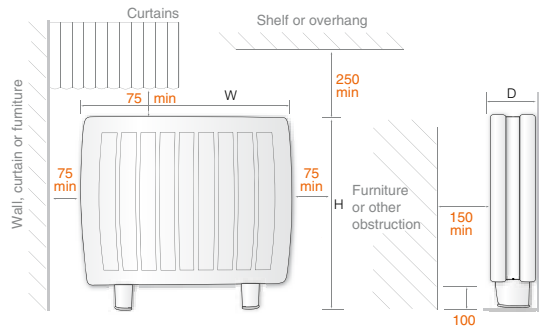

Model	Input (kW)	Output (kW)	Radiant (kW)	Height (mm)	Width (mm)	Depth (mm)	Weight (kg)	Max. storage capacity (kWh)
DUO300N	1.3	0.7	0.38	712	600	130 + 10	65	9.1
DUO400N	1.95	1	0.47	712	830	130 + 10	94	13.65
DUO500N	2.6	1.4	0.54	712	1060	130 + 10	124	18.2

# CXLSN

Combination Storage Heater



This product is not Lot 20 compliant.  
Replacement model XLE on page 22.

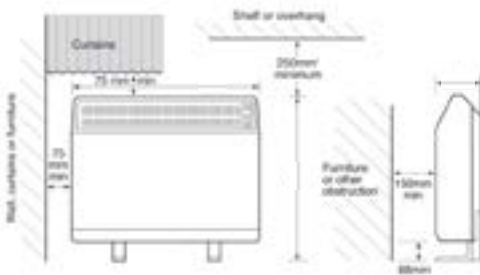

## Installation

Floor standing and fixed to wall via wall fixing bracket.

## IP Rating

IPX2.

## Cable Entry Point

Bottom right. No cable supplied.

## Thermal Cut-out

Bi-metal - manual reset.

## Element

Storage: Incoloy sheathed in units of 850W.

Convecter: Stitched ribbon - can be de-rated by 50% on installation.

## Construction

Galvanised finish sheet steel base, mounted on steel feet, supporting double skin front and outer panels. One piece front panel / grille assembly.

## Controls

Mechanical thermostat.

## Colour

White.

Model	Input (kW)	Height (mm)	Width (mm)	Depth (mm)	Storage bricks required	Weight (kg)	Weight inc. bricks (kg)	Convecter (W)	Max. storage (kWh)
CXLS12N	1.7	706	565	193	8	19.5	77	900	11.9
CXLS18N	2.55	706	793	193	12	24	111	1450	17.85
CXLS24N	3.4	706	1021	193	16	29.5	146	2000	23.8



# XLSN

Automatic Storage Heater

## Installation

Floor standing and fixed to wall via wall fixing bracket.

## IP Rating

IPX2.

## Cable Entry Point

Bottom right. No cable supplied.

## Thermal Cut-out

Bi-metal - manual reset.

## Element

Incoloy sheathed in units of 850W.

## Construction

Galvanised finish sheet steel base, mounted on steel feet, supporting double skin front and outer panels. One piece front panel / grille assembly.

## Controls

Mechanical thermostat.

## Colour

White.



This product is not Lot 20 compliant.  
Replacement model XLE on page 22.

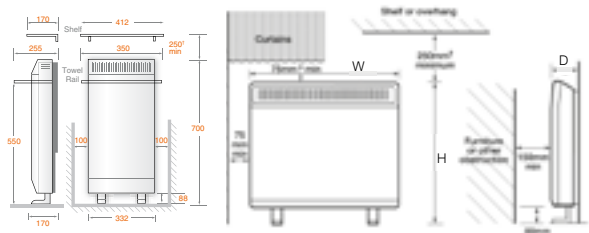

Model	Input (kW)	Height (mm)	Width (mm)	Depth (mm)	Storage bricks required	Weight (kg)	Weight inc.bricks (kg)	Max. storage (kWh)
XLS6N	0.85	700	332	170	4	11	41	5.95
XLS12N	1.7	706	565	146	8	20	76	11.9
XLS18N	2.55	706	793	146	12	26	109	17.85
XLS24N	3.4	706	1021	146	16	32	144	23.8

# Kitchen & Bathroom



# BPH

Bathroom Panel Heater

## Installation

Supplied with metal wall bracket.

## IP Rating

IP25.

## Cable Entry Point

Bottom right. 1.3m cable length.

## Thermal Cut-out

Auto-reset type.

## Element

Extruded aluminium plate element operated via an advanced controller equipped with seasonal adjustment to prevent room temperature overshoot.

## Construction

Polyester powder coated steel or mirror front panel provided convection heat with a brushed aluminium towel rail.

## Controls

Lot 20 compliant with electronic seven day time and temperature.

## Colour

White metal (M) / mirrored glass (G).



Also available in mirrored glass finish.



Model	Output (kW)	Height (mm)	Width (mm)	Depth (mm)	Weight (kg)
BPH100G	1.0	1073	418	271	19.0
BPH100M	1.0	1100	430	265	12.0

# TDTR

Towel Rail

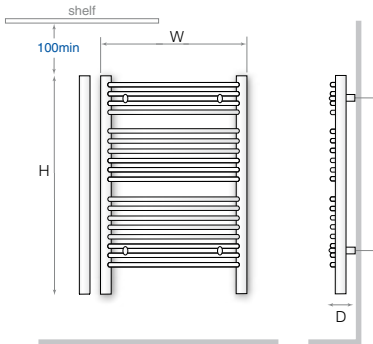

## Installation

Supplied with metal wall brackets.

## IP Rating

IPX5.

## Cable Entry Point

Bottom left. 1m cable length.

## Thermal Cut-out

Built-in temperature limiter and overheat protection.

## Element

Submersion element with temperature limiter and fuse link.

## Construction

Sealed steel shell, D-shaped upright bars.

## Colour

Chrome / White.

Model	Colour	Output (W)	Height (mm)	Width (mm)	Depth (mm)	Weight (kg)	No. of rails
TDTR175W	White	175	610	453	80-100	6	12
TDTR350W	White	350	843	602	95-115	11	18
TDTR175C	Chrome	120	610	453	80-100	6	12
TDTR350C	Chrome	250	843	602	95-115	11	18

# CPTS

Towel Rail

## Installation

Supplied with metal wall brackets.

## IP Rating

IPX5.

## Cable Entry Point

Bottom left. 1m cable length.

## Thermal Cut-out

Built-in temperature limiter and overheat protection.

## Element

Submersion element with temperature limiter and fuse link.

## Construction

Sealed steel shell. Circular tubed upright bars. Vertically mounted element.

## Colour

Chrome / White.

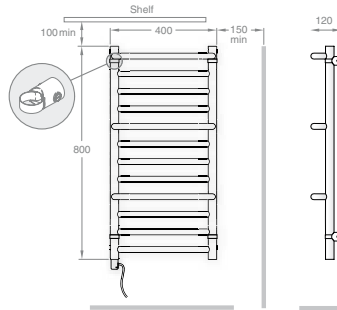

Model	Colour	Output (W)	Height (mm)	Width (mm)	Depth (mm)	Weight (kg)	No. of rails
CPTS	Chrome	120	800	400	120	7.4	12
CPTSW	White	150	800	400	120	7.4	12

# BR

Towel Rail



## Installation

Supplied with metal wall brackets.

## IP Rating

IPX5.

## Cable Entry Point

Bottom left. 1m cable length.

## Thermal Cut-out

Built-in over temperature cut-out.

## Element

Vertical mounted immersion element.

## Construction

Sealed, liquid filled steel shell.  
Water based fluid with glycol frost/ corrosion inhibitor.

## Colour

Chrome / White.

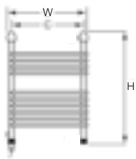

BR150C

BR150C

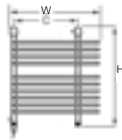

BR350C

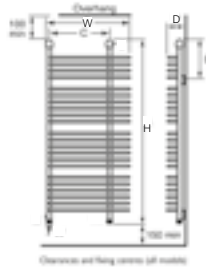

Dimensions and fixing centres (all models)

Model	Output electric (W)	Output water (W)	Height (mm)	Width (mm)	C (mm)	Depth (mm)	E (mm)	Weight (kg)	No. of rails
BR150C	150	320	665	430	385	155	268	6.5	10
BR350C	350	750	1003	630	603	155	268	13	16
BR400W	400	840	1003	630	447	155	268	15	16

### Installation

Supplied with metal wall brackets.

### IP Rating

IPX5.

### Electrical connections

Left or right. 1m cable length.

### Thermal Cut-out

Built-in temperature limiter and overheat protection.

### Element

Sealed electrical element.

### Construction

Tubular steel, Water-glycol filled.

### Colour

Chrome / White.

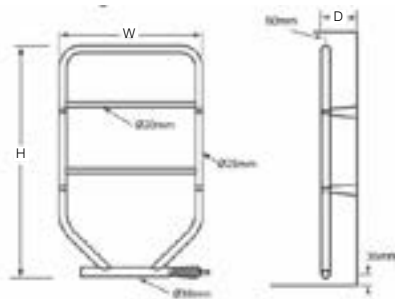

Model	Colour	Output (W)	Height (mm)	Width (mm)	Depth (mm)
TTRC90/W	Chrome	60	616	533	93
TTRS120/W	White	120	616	533	93
TTRC130W	Chrome	90	851	533	93
TTRC150/W	Chrome	120	851	787	93
TTRS175/W	White	175	851	533	93

# S

Towel Rail

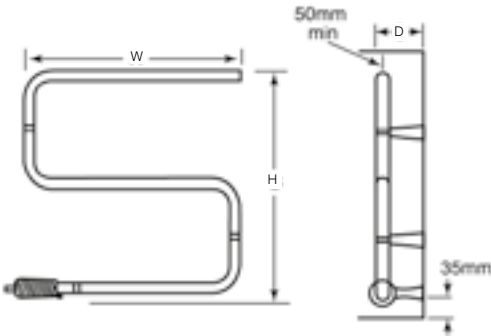

## Installation

Supplied with metal wall brackets.

## IP Rating

IPX4.

## Cable Entry Point

Left or right. 1m cable length.

## Thermal Cut-out

Surface temperature regulated by steady state dissipation of heat from the low wattage element.

## Element

Vertical mounted immersion element.

## Construction

Tubular Steel, Dry element.

## Colour

Chrome / White.

Model	Colour	Output (W)	Height (mm)	Width (mm)	Depth (mm)
S50C	Chrome	45	555	568	93
S50W	White	45	555	568	93



# LSTS

Low Surface Temperature Towel Rail

## Installation

Supplied with metal wall brackets.

## IP Rating

IPX4.

## Cable Entry Point

Left or right. 1m cable length.

## Thermal Cut-out

Surface temperature regulated to a maximum of 43°C by automatic resetting thermal cut-out.

## Element

Vertical mounted immersion element.

## Construction

Tubular Steel, Dry element.

## Colour

White.

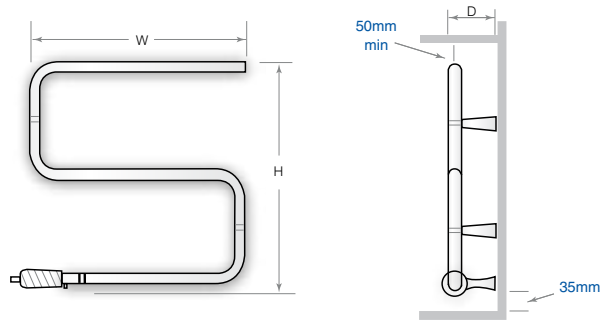

Model	Output	Height (mm)	Width (mm)	Depth (mm)	Weight (kg)
LSTS	15	555	568	93	1.7

# FSC

Towel Rail Control



## IP Rating

IPX4.

## Cable Entry Point

Bottom left. No cable supplied.

## Colour

White / Chrome.

- Allows the towel rail to be switched on or off, and for the surface temperature to be adjusted.
- Five settings that progressively reduce the temperature of the towel rail and also the energy that it uses.
- 'Eco' mode, which allows you to dry a towel without having to leave the towel rail on indefinitely.
- Compatible with Dimplex CPT, TDTR, BR, TR and S rails.

Model	Height (mm)	Width (mm)	Depth (mm)	Weight (kg)
FSCC	87mm	87mm	25mm*	0.1
FSCW	87mm	87mm	25mm*	0.1

\*Total product depth is 25mm, 5mm of which will be recessed into the backbox.

# FX20

Downflow Heater

## Installation

Two upper keyhole slots are provided together with a third fixing hole.

## IP Rating

FX20 - IPX2.  
FXIPX4 - IPX4.

## Cable Entry Point

Middle, top. No cable supplied.

## Thermal Cut-out

Manually resettable thermal overload cut out and thermal fuselink.

## Element

2kW stitched type with thermal fuse protection. Adjustable to 1kW on installation.

## Construction

Double insulated plastic case. Moulded in flame retardant self extinguishing grade nylon.

## Colour

White.



FX20



FX20IPX4

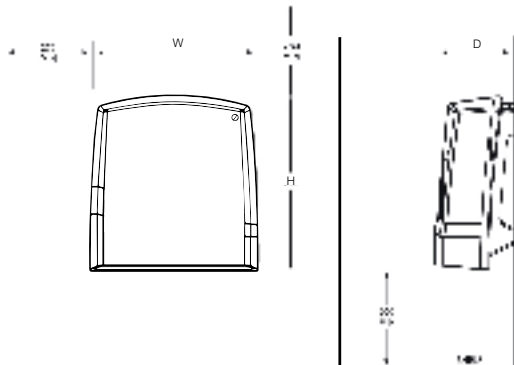

Model	Output (kW)	Height (mm)	Width (mm)	Depth (mm)	Weight (kg)
FX20V	2	242	229	109	1.1
FX20VE	2	242	229	109	1.1
FX20VL	2	242	229	109	1.1
FX20IPX4	2	267	250	131	1.4
FX20EIPX4	2	267	250	131	1.4

# BFH

Plinth Heater



Intertek

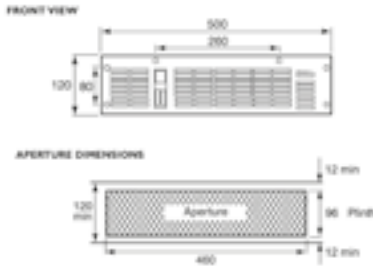

## Installation

Adjustable rear support bracket for horizontal installation.

## Cable Entry Point

Rear left. 2m cable length.

## Thermal Cut-out

Interrupt supply to reset type.

## Element

Fully strung, helically wound, 800W and 1600W combine to give 2400W maximum output.

## Construction

Front air inlet with integral axial fan and heating element.

## Controls

Integrated (T) and remote control (R) versions available.

## Colour

Brown / White / Stainless Steel (all included).

Model	Max. output (kW)	Optional output (W)	Height (mm)	Width (mm)	Depth (mm)	Weight (kg)
BFH24BWST	2.4	800, 1600	120	500	210	4.5
BFH24BWSR	3.4	800, 1600	120	500	210	4.5

# BUH

Plinth Heater

## Installation

Adjustable rear support bracket for horizontal installation. Supplied with flexible hoses and isolating valves.

## Cable Entry Point

Rear left. 2m cable length.

## Thermal Cut-out

Interrupt supply to reset type.

## Element

Wet heat exchanger for central heating system.

## Construction

Front air inlet with integral axial fan and heat exchanger for wet heating systems.

## Colour

Brown / White /  
Stainless Steel (all included).



Intertek

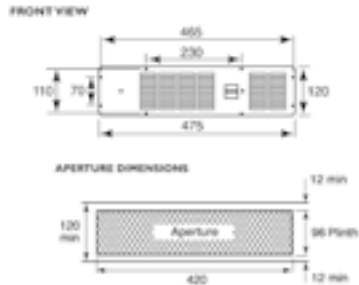

Model	Max. output (kW)	Optional output (W)	Height (mm)	Width (mm)	Depth (mm)	Weight (kg)
BUH19B/W/S	2.4	800, 1600	120	500	235	3.9

# IP Rating Chart

Zones:

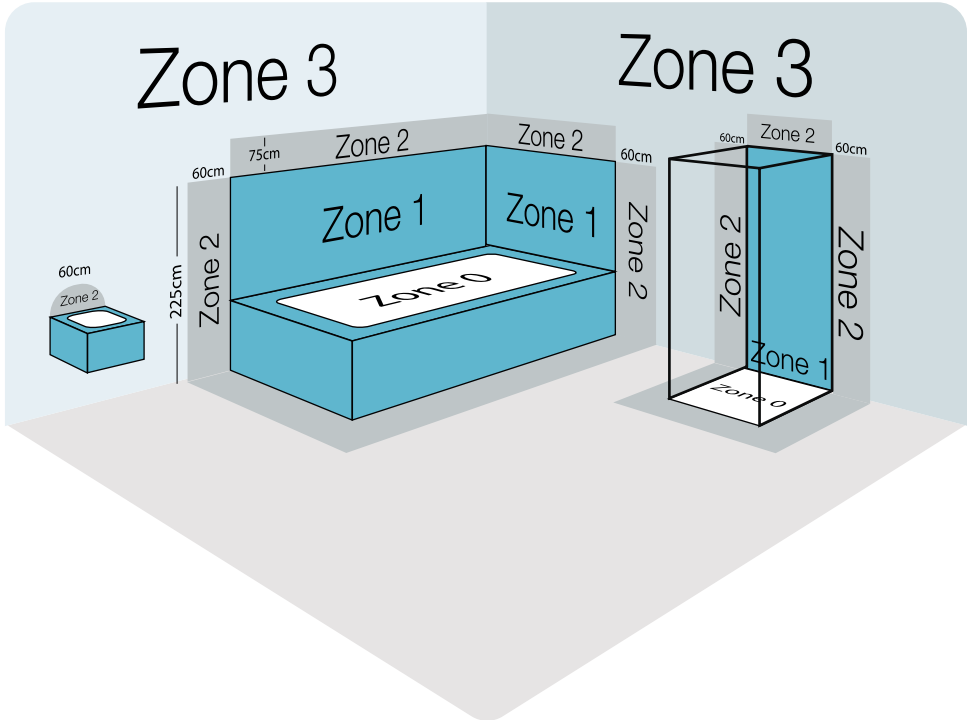

## Zone 0

This zone requires a minimum of IP67.

## Zone 1

Requires a minimum of IPX4. This is the area directly above a bath and within a shower cubicle.

## Zone 2

Same as above, requires a minimum of IPX4.

## Outside of Zones

For areas outside of these zones (previously known as Zone 3), normal rules apply and no IP rating is required.

## Product

## IP

## Page

Product	IP	Page
BPH Bathroom Panel Heater	IPX5	27
TDTR Towel Rail	IPX5	28
CPTS Towel Rail	IPX5	29
BR Towel Rail	IPX5	30
TTR Towel Rail	IPX5	31
S Towel Rail	IPX4	32
LST Towel Rail	IPX4	33
FX20IPX4 Downflow Heater	IPX4	35
FX20EIPX4 Downflow Heater	IPX4	35



# Miscellaneous Heating

# ECOT

Tubular Heater

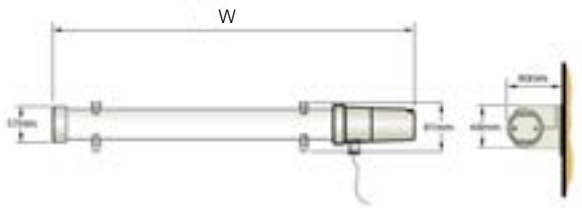

## Installation

Horizontal wall mounting via supplied wall brackets.

## IP Rating

IPX4.

## Cable Entry Point

Left or right. 1.5m cable length.

## Thermal Cut-out

Auto-reset type.

## Element

Coiled type.

## Construction

Tubular construction encloses heating element with thermostatic controls.

## Controls

Mechanical thermostat.

## Colour

White.

Model	Loading (W)	Height (mm)	Width (mm)	Depth (mm)	Weight (kg)
ECOT1FT	40	81	408	80	0.5
ECOT2FT	80	81	713	80	0.6
ECOT3FT	120	81	1018	80	0.8
ECOT4FT	160	81	1323	80	1
ECOT5FT	200	81	1630	80	1.1
ECOT6FT	240	81	1933	80	1.3



# MPH

Coldwatcher

## Installation

Floor standing or fixed to wall via fixing holes in the wall bracket.

## IP Rating

IPX4.

## Cable Entry Point

Bottom right. 1.8m cable length.

## Thermal Cut-out

Interrupt supply to reset type.  
Professionally tested for frost protection to BS EN60675:1995.

## Element

Mineral filled type.

## Construction

Rugged and long lasting steel construction encloses element.

## Controls

Thermostatic with frost protection.

## Colour

Grey.

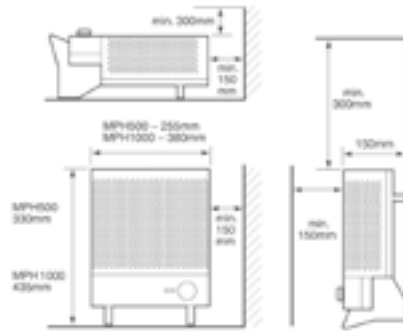

Model	Output (W)	Height (mm)	Width (mm)	Depth (mm)	Weight (kg)
MPH500	500	330	255	150	2.56
MPH1000	1000	435	380	150	3.88

# DXLWP

Portable Panel Heater



Intertek



## Installation

Floor standing or fixed to wall via fixing holes in the wall bracket.

## IP Rating

IPX0.

## Cable Entry Point

Bottom right - plug attached.  
1.5m cable length.

## Thermal Cut-out

Overheat safety cut-out.

## Element

Foil.

## Construction

Steel case mounted on feet or wall brackets encloses convective element.

## Controls

ARLWP800Ti - Choice of heat settings.  
TI - 24hr programmable timer.

## Colour

White.

Model	Output (W)	Height (mm)	Width (mm)	Depth (mm)	Depth (wall) (mm)	Weight (kg)
DXLWP400	400	530	600	200	30	4.6
DWLP400TI	400	530	600	200	30	4.6
DXLWP800	800	530	800	200	30	5.9
ARLWP800Ti	800	530	800	200	30	5.9

# IRX

Infra-red Heater

## Installation

Horizontal wall mounting via supplied mounting plate.

## IP Rating

IP24.

## Cable Entry Point

Centre. No cable supplied.

## Element

Spiral element(s) encased in transparent insulating silica sleeves.

## Construction

Steel case mounted on wall brackets encloses convective element.

## Controls

Pull cord operation.  
IRX200N - Choice of heat settings.

## Colour

Silver.

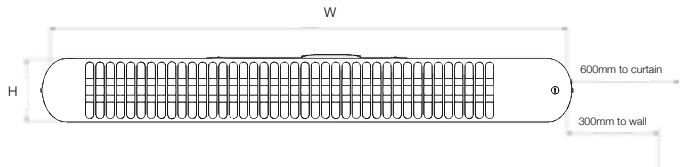

Model	Output (kW)	Height (mm)	Width (mm)	Depth (mm)	Weight (kg)
IRX50N	0.5	114	764	92.5	2
IRX120N	1.2	114	764	92.5	2
IRX200N	2	114	764	92.5	2.1

# Portable Heating



# DXTT3

Garage Heater

## Installation

Horizontal wall mounting via supplied mounting plate or free standing.

## IP Rating

IP21.

## Cable Entry Point

Bottom back. 1.5m cable length.

## Thermal Cut-out

Auto-reset type.

## Element

PTC dual ceramic.

## Construction

Plastic with steel grille.

## Controls

Built in mechanical room thermostat.

## Colour

Black and yellow.

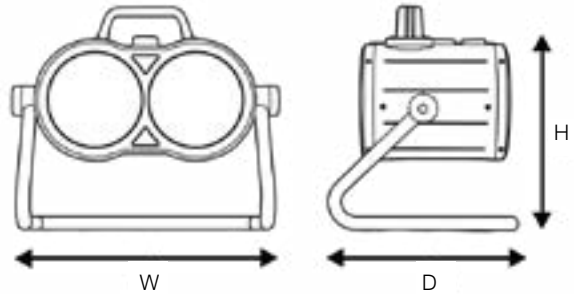

Model	Output (kW)	Height (mm)	Width (mm)	Depth (mm)	Weight (kg)
DXTT3	1.5/3	280	470	290	4.65

# OFX/MK1

Oil-Filled Panel Heater



Intertek

## OFX RANGE

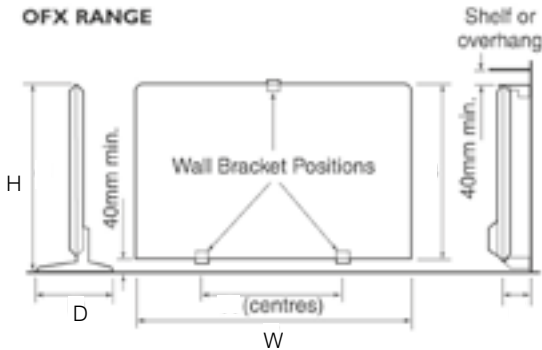

## Installation

Floor standing or fixed to wall via fixing holes in the wall bracket.

## Cable Entry Point

Bottom right. 1.5m cable length.

## Thermal Cut-out

OFX - Manual and auto-reset type.

MK1 - Manual and auto-reset type.

## Element

OFX - Incoloy sheathed.

MK1 - Incoloy sheathed.

## Construction

Oil-filled steel case mounted on feet or wall brackets encloses convective element.

## Controls

Thermostatic.

## Colour

White.

Model	Output (kW)	Heat Settings	Timer	Height (mm)	Width (mm)	Depth (mm)	Weight (kg)
OFX750/(TI)	0.75	N/A	Y-TI	500	741	230	9.5
OFX1000/(TI)	1	N/A	Y-TI	586	854	230	12.9
OFX1500/(TI)	1.5	N/A	Y-TI	670	1084	230	17.8
B48	0.75	N/A	x	694	635	220	9.5
C412	1	N/A	x	694	905	220	14
D416	1.5	N/A	x	694	1170	220	18.5
E420	2	N/A	x	694	1438	220	23

# CADIZ ECO

Oil-Free Column Heater

## Installation

Supplied with a plug, no installation required.

## Cable Entry Point

Front, Bottom, Middle.  
1.5m cable length.

## Thermal Cut-out

Overheat safety cut-out.

## Element

Micathermic elements.

## Construction

Steel case mounted on castors encloses convective element.

## Controls

Electronic climate control.

## Colour

White.

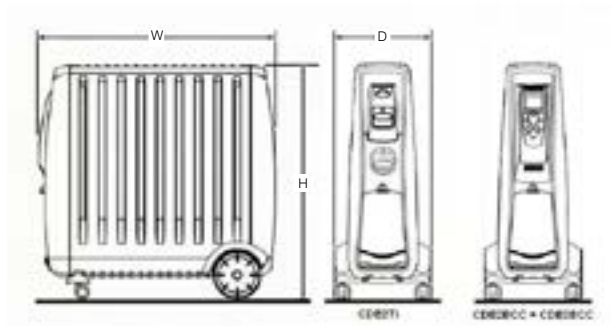

Model	Output (kW)	Height (mm)	Width (mm)	Depth (mm)	Weight (kg)
CDE2Ti	2	605	614	250	8.4
CDE2ECC	2	605	614	250	8.4
CDE3ECC	3	605	770	250	11.1

# OFRC

Oil-Free Column Heater



Intertek

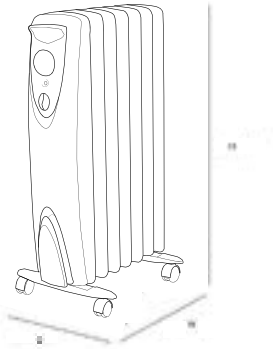

## Installation

Supplied with a plug, no installation required.

## Cable Entry Point

Front, Bottom, Middle.  
1.5m cable length.

## Thermal Cut-out

Auto-reset type.

## Element

Sheathed element.

## Construction

Steel case, oil-filled column, mounted on castors.

## Controls

Variable thermostatic control.

## Colour

White.

Model	Output (kw)	Height (mm)	Width (mm)	Depth (mm)	Weight (kg)	No. of fins
OFRB7N	0.7	446	194	296	5.4	6
OFRC15N	1.5	622	370	280	7.9	7
OFRC20N	2	622	430	280	9.8	9
OFRC20TiN	2	622	430	280	9.8	9



# OFC

Oil-Free Column Heater

## Installation

Supplied with a plug, no installation required.

## Cable Entry Point

Front, Bottom, Middle.  
1.5m cable length.

## Thermal Cut-out

Auto-reset type.

## Element

Sheathed element.

## Construction

Steel case, oil-filled column,  
mounted on castors.

## Controls

Thermostatic control with choice of  
heat settings.  
Timer.

## Colour

White.

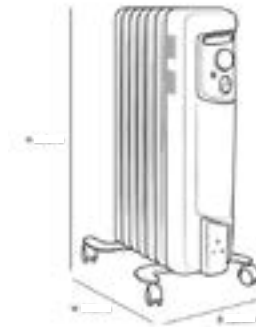

Model	Output (kW)	Heat Settings	Timer	Height (mm)	Width (mm)	Depth (mm)	Weight (kg)
OFC1500	1.5	2	x	635	280	398	10
OFC2000	2	2	✓	635	290	440	11
OFC2000TI	2	2	✓	635	290	440	11

# DXU/DXGLO/DXFF

Portable Heater



DXGLO

DXU

FXFF



Intertek

## Installation

Supplied with a plug, no installation required.

## Cable Entry Point

DXU / DXGLO2 - Bottom middle.  
DXFF - Bottom right.  
All 1.5m cable length.

## Thermal Cut-out

Manual reset cut-out.

## Element

Nichrome wire element.

## Construction

Plastic housing encloses convective element. Free-standing with built-in feet.

## Controls

See table.

## Colour

DXU - Grey.  
DXGLO2 - Black.  
DXFF - White.

**DO NOT** use the heaters on deep pile carpets or the long hair type of rugs, or less than 750mm (30") away from any overhanging surface. Keep combustible materials such as drapes and other furnishings clear from the front, sides and rear of the heater.

Model	Output (kW)	Thermostat	Mains neon	Cool Blow	Height (mm)	Width (mm)	Depth (mm)	Weight (kg)	Colour
DXUF20T/N	2	✓	✓	✓	238	247	184	1.4	Grey
DXUF30T/N	3	✓	✓	✓	238	247	184	1.4	Grey
DXGLO2	2	Electronic	LCD	✓	278	230	158	1.5	Black
DXSTG25	2	Electronic	LED	✓	825	263	263	4.4	Black
DXFF20TSN	2	✓	✓	✓	114	253	245	1.2	White
DXFF30TSN	3	✓	✓	✓	114	253	245	1.2	White
DXDDA12	2	✓	✓	✓	114	253	245	1.2	Pink
DXDFB2	2	✓	✓	✓	114	253	245	1.2	White

# Contrast

Convactor Heater

## Installation

Supplied with a plug, no installation required.

## Cable Entry Point

Bottom Right. 1.5m cable length.

## Thermal Cut-out

Manual reset cut-out.

## Element

Stitched.

## Construction

Steel case mounted on plastic feet or wall brackets encloses convective element.

## Controls

See table.

## Colour

White.

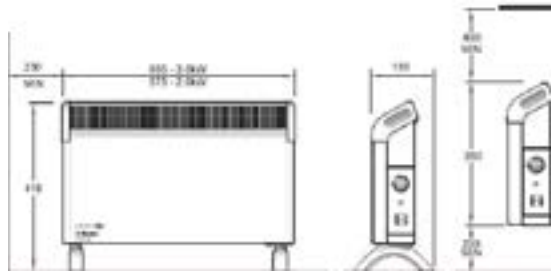

Model	Output (kW)	Timer	Turbo Fan	Height (mm)	Width (mm)	Depth (mm)	Weight (kg)
DX20	2	X	X	350 + 68 (feet)	575	104 + 92 (feet)	358
DX20Ti	2	✓	X	351 + 68 (feet)	575	105 + 92 (feet)	358
DXC30	3	X	X	352 + 68 (feet)	575	106 + 92 (feet)	478
DX30Ti	3	✓	X	353 + 68 (feet)	575	107 + 92 (feet)	478
DXC30FTi	3	✓	✓	354 + 68 (feet)	575	108 + 92 (feet)	478



# Commercial Heating

AC

Over Door Heater

## Installation

Designed for wall or ceiling installation. AC3CN is designed for installation into plaster or suspended ceilings. Maximum recommended mounting height: 2.3m

## IP Rating

IP21.

## Cable Entry Point

Centre bottom. No cable supplied, designed for permanent connection to the fixed wiring through an adjacent double-pole switch or conduit connection.

## Thermal Cut-out

Electrical hold reset cut-outs.  
2x manual reset cut-outs (AC3CN).

## Element

Wire stitched element.

## Construction

Pressed steel case with ABS end caps and contrasting switches.  
AC3CN - Pressed steel with hinged liner white grille.

## Colour

White.



AC3N



AC3RN

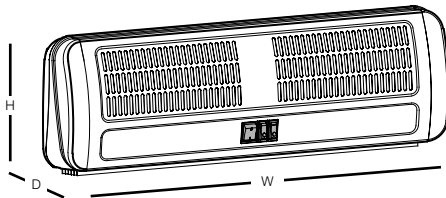

Model	Output (kW)	Air Volume (m <sup>3</sup> /h)	Max air speed	Length (mm)	Height (mm)*	Depth (mm)	Weight (kg)
AC3N	1.5/3.0	212	5.0	605	200	135	5.1
AC3RN	1.5/3.0	212	5.0	605	200	135	5.3
AC45N	2.25/4.5	248	5.0	605	200	135	5.2
AC6N	3.0/6.0	446	525.0	905	200	135	7.2
AC3CN (recessed)	1.5/3.0	175	3.2	595	184	295	8.7

\*Add 14mm for total installed height.

# CAB

Commercial Air Curtain

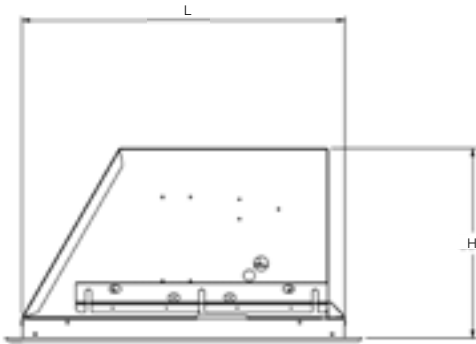

CAB Recessed

## Installation

Easy-fit bracket.

## IP Rating

IPX0.

## Cable Entry Point

Centre back. No cable supplied.

## Thermal Cut-out

Manual reset cut-out.

## Element

Finned Metal Sheathed Elements.

## Construction

Steel case, wall mounted or suspended with suspension rods.

## Controls

Electronic.

## Colour

White.

### Wall Fixing

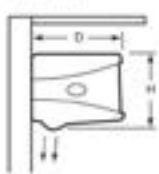

### Ceiling Mounted

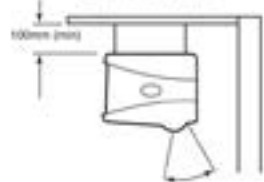

CAB

Model	Output	Air Volume	Airstream width	Length (mm)	Height (mm)	Depth (mm)	Weight (kg)
Electrically heated							
CAB10E	4.5 / 9.0	1200	1.0	1065	262	321	205.5
CAB15E	6.75 / 13.5	1800	1.5	1569	262	321	29
CAB20E*	9.0/18.0	2400	2.0	2130	262	321	41
Water Heated (at 82/71°C - LPHW)							
CAB10W	9.0	1100	1.0	1065	262	321	18
CAB15W	13.5	1700	1.5	1569	262	321	24.5
CAB20W*	18.0	2200	2.0	2130	262	321	36
Ambient and cold store							
CAB10A	N/A	1200	1.0	1065	262	321	15.5
CAB15A	N/A	1800	1.5	1569	262	321	21.5
CAB20A*	N/A	2400	2.0	2130	262	321	31
Electrically heated and recessed							
CAB10ER	4.5/9.0	1200	1.0	1224	267	639	26
CAB15ER	6.75/13.5	1800	1.5	1724	267	639	35
CAB20ER*	9.0/18.0	2400	2.0	2450	267	639	54.5
Water Heated (at 82/71°C - LPHW) and recessed							
CAB10WR	9.0	1100	1.0	1224	267	639	26
CAB15WR	13.5	1700	1.5	1724	267	639	35
CAB20WR*	18.0	2200	2.0	2450	267	639	54.5
Recessed ambient and cold store							
CAB10AR	N/A	1200	1.0	1224	267	639	26
CAB15AR	N/A	1800	1.5	1724	267	639	35
CAB20AR*	N/A	2400	2.0	2450	267	639	54.5

# DAB

Commercial Air Curtain

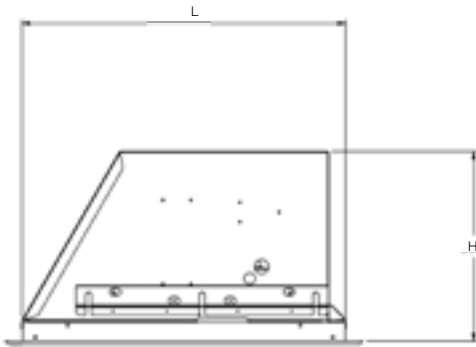

DAB Recessed

## Installation

Easy-fit bracket.

## IP Rating

IPX0.

## Cable Entry Point

Centre back. No cable supplied.

## Thermal Cut-out

Manual reset cut-out.

## Element

Finned Metal Sheathed Elements.

## Construction

Steel case, wall mounted or suspended with suspension rods.

## Controls

Electronic.

## Colour

White.

Wall Fixing

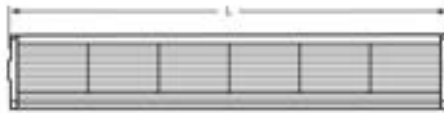
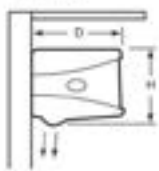

Ceiling Mounted

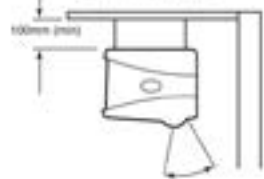

DAB



Model	Output	Air Volume	Airstream width	Length (mm)	Height (mm)	Depth (mm)	Weight (kg)
Electrically heated							
DAB10E	6.0/12.0	3000	1.0	1057	360	390	26.5
DAB15E	9.0/18.0	4000	1.5	1557	360	390	35.0
DAB20E*	12.0/24.0	6000	2.0	2114	360	390	53.0
Water Heated (at 82/71°C - LPHW)							
DAB10W	12.0	2500	1.0	1057	360	390	25.0
DAB15W	18.0	3500	1.5	1557	360	390	32.0
DAB20W*	24.0	5000	2.0	2114	360	390	50.0
Ambient and cold store							
DAB10A	N/A	3000	1.0	1057	360	390	21.5
DAB15A	N/A	4000	1.5	1557	360	390	27.5
DAB20A*	N/A	6000	2.0	2114	360	390	43.0
Electrically heated							
DAB10ER	6.0/12.0	3000	1.0	1224	337	667	31.5
DAB15ER	9.0/18.0	4000	1.5	1724	337	667	43.0
DAB20ER*	12.0/24.0	6000	2.0	2448	337	667	63.0
Water Heated (at 82/71°C - LPHW)							
DAB10WR	12.0	2500	1.0	1224	337	667	31.5
DAB15WR	18.0	3500	1.5	1724	337	667	43.0
DAB20WR*	24.0	5000	2.0	2448	337	667	63.0
Ambient and cold store							
DAB10AR	N/A	3000	1.0	1224	337	667	31.5
DAB15AR	N/A	4000	1.5	1724	337	667	43.0
DAB20AR*	N/A	6000	2.0	2448	337	667	63.0

# IAB

Industrial Air Curtain



## Installation

M12 threaded drop (not supplied).

## IP Rating

IPX0.

## Cable Entry Point

Middle Back. No cable supplied.

## Thermal Cut-out

Auto-reset type.

## Element

- Finned metal sheathed elements. - Centrifugal, double inlet blowers.

## Construction

Powder-coated steel case with removable access panel.

## Control

Electronic modular system.

## Colour

White.

Model	Output (kW)	Air Volume (m <sup>3</sup> /h)	Max door width (m)	Length (mm)	Height (mm)	Depth (mm)	Weight (kg)
Electrically heated							
IAB10E	12/24	4500	1.0	1100	700	600	80.0
IAB15E	18/36	6900	1.5	1600	700	600	120.0
Water Heated (at 82/71°C - LPHW)							
IAB10W	27	4500	1.0	1100	700	600	80.0
IAB15W	41	6900	1.5	1600	700	600	120.0
Ambient and cold store							
IAB10A	N/A	4500	1.0	1100	700	600	80.0
IAB15A	N/A	6900	1.5	1600	700	600	120.0

# ARC

Architectural Air Curtain

## Installation

Horizontal (above entrance) using threaded rod (not supplied) / Vertical (mechanical fixed to floor using optional foot).

## IP Rating

IPX0.

## Cable Entry Point

Top left (Horizontal).  
Bottom (Vertical).  
No cable supplied.

## Thermal Cut-out

Manual reset cut-out.

## Element

- Finned metal sheathed elements.
- Tangential, 150mm fan.

## Construction

Stainless steel.

## Control

Electronic.  
BEMS/BMS connectivity.

## Colour

Brushed/polished stainless steel.

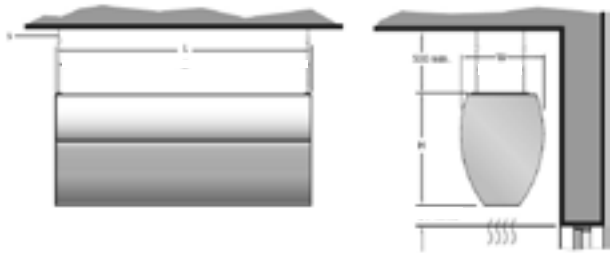

Model	Length* (mm)	Height* (mm)	Depth* (mm)	Weight (kg)
ARC10	1200	450	360	55-65
ARC15	1700	450	360	82.5-95
ARC20	2200	450	360	110-130

\* Sample dimensions only.

# CFH

Commercial Fan Heater

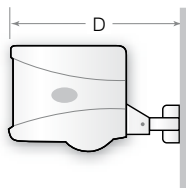
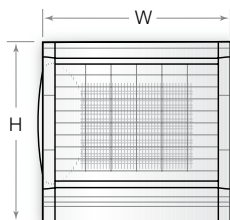

## Installation

Horizontal wall mounting via supplied mounting plate.

## IP Rating

IPX4.

## Cable Entry Point

Back left, bottom.  
No cable supplied.

## Thermal Cut-out

Manual reset cut-out.

## Element

Finned metal sheathed element.

## Construction

Corrosion-resistant body with durable colour. Finned/sheathed heating elements with rigid steel outlet grille vanes to direct airflow.

## Colour

White.

Model	Output (kg)	Air-off temp (°C)	Height (mm)	Width (mm)	Depth (mm)	Max Depth (mm)	Weight (kg)
CFH60	6.0	40	360	386	565	630	13.5
CFH90	9.0	55	360	386	565	630	14.5
CFH120	12.0	65	360	386	565	630	14.5

# CFCH

Commercial Controller

### Centrally controlled building heating



### Focused heating with single point control

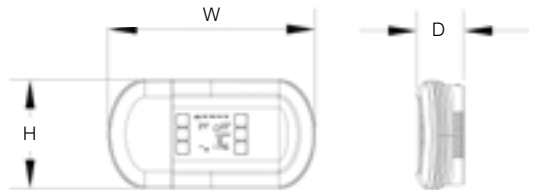

Control	Max	Heater communication	Supply	Height (mm)	Width (mm)	Depth (mm)
CFCH	10 heaters	CAT 5e ethernet / RJ45	220-240V~1PN	114	217	49

# CFS

Commercial Fan Heater

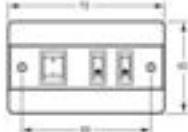
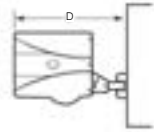
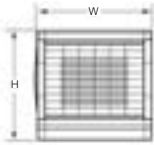

## Installation

Horizontal wall mounting via supplied mounting plate.

## IP Rating

CFS30 - IP24.  
CFS60 - IPX4.

## Cable Entry Point

Back left, bottom.  
No cable supplied.

## Thermal Cut-out

Electrical reset (CFS30),  
Manual reset (CFS60).

## Element

Metal sheathed (CFS30)  
Finned metal sheathed (CFS60).

## Construction

Heavy-duty corrosion-resistant case.

## Control

Wall-mounted control switch plate.

## Colour

White.

Model	Output (kW)	Air Flow (m <sup>3</sup> /h)	Throw (m)	Air-off temp (°C)	Height (mm)	Width (mm)	Depth (mm)	Weight (kg)
CFS30	3.0	400	4.5	35	262	306	495	7.6
CFS60	6.0	750	8.0	45	360	386	565	13.5

## PFH

Commercial Fan Heater

## Installation

Multi-directional wall bracket giving 40° vertical and 120° horizontal adjustment.

## IP Rating

IPX0.

## Cable Entry Point

Bottom. No cable supplied.

## Thermal Cut-out

Electric reset.

## Element

Wire strung.

## Construction

Nylon case construction.

## Control

Thermostatic.  
Remote control supplied (R).

## Colour

Grey.



Intertek

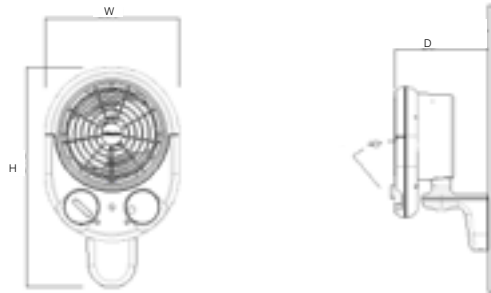

Model	Output (kW)	Air Flow (m <sup>3</sup> /h)	Height (mm)	Width (mm)	Depth (mm)	Weight (kg)
PFH30	3.0	200	378	230	226	1.3
PFH30R	3.0	200	378	230	226	1.6

# CXD

Ceramic Heater



## Installation

Horizontal wall mounting via supplied mounting arm/bracket.

## IP Rating

IPX4.

## Cable Entry Point

Middle. No cable supplied.

## Element

Ceramic encased aluminium.

## Construction

Steel case mounted on wall brackets encloses convective element.

## Control

Can be used with sensors\* or push switches for automatic control.

## Colour

Matt black.

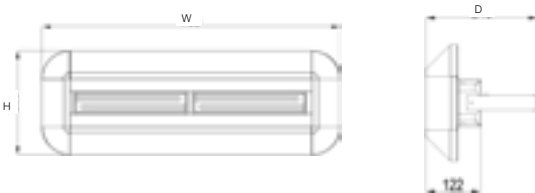

Model	Output (kW)	No. of Lamps	Height (mm)	Width (mm)	Depth (mm)	Weight (mm)	Recommended height (mm)
CXD2000V	2.0	2	380	442	302	5.35	2.0
CXD2000H	2.0	2	255	735	248	5.1	2.0

\*To order heater and PIR sensor as a single pack, order CXD2000VPIR or CXD2000HPIR.



### Installation

Horizontal wall mounting via supplied mounting arm/bracket.

### IP Rating

IPX0.

### Cable Entry Point

Middle. No cable supplied.

### Element

Tungsten element.

### Construction

Powder-coated steel case with electrochemically brightened aluminium and halogen lamp.

### Control

Can be used with sensors\* or push switches for automatic control.

### Colour

Matt black.

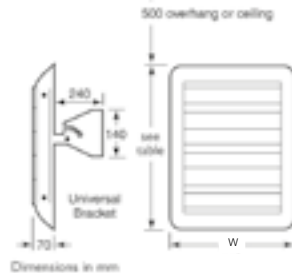

Model	Output (kW)	No. of Lamps	Height (mm)	Width (mm)	Depth (mm)	Weight (mm)	Recommended height (mm)
QXD1500	1.5	1	256	440	310	3.7	2.5
QXD3000	3.0	2	380	440	310	4.3	3.5
QXD4500	4.5	3	506	440	310	5.8	4

\*To order heater and PIR sensor as a single pack, order QXD1500PIR or QXD3000PIR (not suitable for QXD4500).

# OPH

Quartz Heater

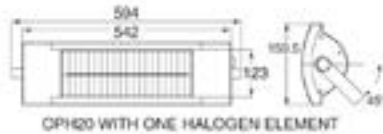
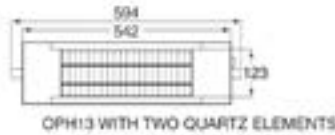

## Installation

Horizontal wall mounting via supplied mounting plate.

## IP Rating

IP24.

## Cable Entry Point

Bottom Right. No cable supplied.

## Element

- OPH13 (Quartz infrared spiral element in transparent silica sleeve).
- OPH20 (Quartz halogen gold coated tungsten element in glass sleeve).

## Construction

Aluminium case with electrochemically brightened aluminium reflector and fitted chromium plate mild steel guard.

## Control

PIR sensor available.\*

## Colour

Two-tone silver.

Model	Output (kW)	Height (mm)	Width (mm)	Depth (mm)	Weight (kg)	Element	Mounting Height (m)
OPH13	1.3	159	594	144	4	Infra-red	2-2.3
OPH20	2.0	159	594	144	4	Halogen	2-2.4

\*To order heater and sensor as a single pack, order OPH13PIR or OPH20PIR.

# WFC/E

Commercial Fan Heater

## Installation

Keyhole-mounting slots.

## Cable Entry Point

Bottom Left. No cable supplied.

## Thermal Cut-out

Auto-reset type.

## Element

Twin helically wound fully sprung open coiled elements (2kW + 1kW).

## Construction

Pressed steel front panel and base.

## Control

Variable thermostat range.

Manual mode selection (WFC).

Electronic thermostat (WFE).

## Colour

Black with wood effect ends / silver with black ends.



Intertek

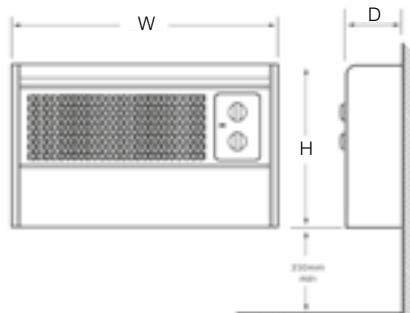

Model	Colour	Output (kW)	Height (mm)	Width (mm)	Depth (mm)	Weight (kg)
WFC3NB	Black	3.0	350	575	120	6.6
WFC3NS	Silver	3.0	350	575	120	6.6
WFE3TNB	Black	3.0	350	575	120	6.6
WFE3TNS	Silver	3.0	350	575	120	6.6

# VFMi

Commercial Storage Heater

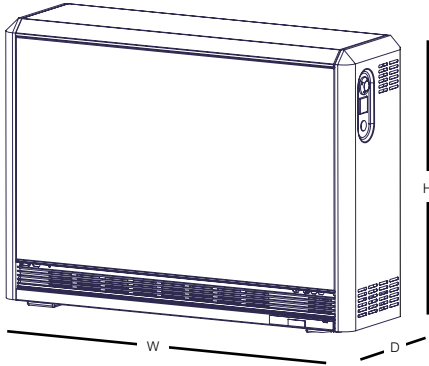

## Installation

Wall fixing is required.

## Cable Entry Point

Right. No cable supplied.

## Thermal Cut-out

Bi-metal - automatic reset.

## Element

Incoloy sheathed, three elements.

## Construction

Galvanised sheet steel base, mounted on pressed steel feet.

## Control

Manual adjust input charge control.

## Colour

White.

Model	Output (kW)	Fan (W)	Height (mm)	Width (mm)	Depth (mm)	Weight (kg)	Storage bricks	Max storage Capacity (kWh)
VFM24i	3.4	15	672	776	285	138	18	24
VFM32i	4.6	15	672	926	285	177	24	32
VFM40i	5.7	25	672	1076	285	216	30	40
VFM48i	6.9	25	672	1226	285	255	36	48

# HAW

Air Warmer

## Installation

Floor fixing points and separate wire guard.

## Cable Entry Point

Left or right side. No cable supplied.

## Thermal Cut-out

Manual reset cut-out.

## Element

Metal sheathed.

## Construction

Cast iron body with black stove enamel finish.

## Colour

Black.



Model	Output (kW)	Height (mm)	Width (mm)	Depth (mm)	Weight (kg)
HAW1000N	1	115	470	207	14

# Water Heating and Renewable Technology



# QWCd

Quantum Electric Water Cylinder

## Installation

Floor standing, vertically mounted on flat, level surface (see operating instructions).

## IP Rating

IPX1.

## Cable Entry Point

Front, bottom, middle.

## Thermal Cut-out

Safety manual reset.

## Element

1 3/4" BSP 3kw Incoloy immersion and boost element.

## Construction

22mm Stainless steel inner vessel, lightweight, strong and corrosion resistant. HIPS/ABS outer cladding, 60 mm CFC/HCFC free injected foam insulation.

## Control

Digital temperature control.

## Colour

Black.



Model	Volume (L)	Height (mm)	Diameter (mm)	T&P Valve (mm)	Imm. 1 (mm)	Imm. 2 (mm)
QWCd125 - 580	125	945	580	720	208	570
QWCd150 - 580	150	1115	580	890	208	650
QWCd210 - 580	210	1490	580	1265	208	820
QWCd250 - 580	250	1765	580	1540	208	1265
QWCd300 - 580	300	2065	580	1840	208	1495

# QWC Slimline

Quantum Electric Slimline Water Cylinder



## Installation

Floor standing, vertically mounted on flat, level surface.

## IP Rating

IPX1.

## Cable Entry Point

Front, bottom, middle.

## Thermal Cut-out

Safety manual reset.

## Element

1 3/4" BSP 3kw Incoloy immersion and boost element.

## Construction

22mm stainless steel inner vessel, lightweight, strong and corrosion resistant. HIPS/ABS outer cladding, 50mm CFC/HCFC free injected foam insulation.

## Control

Digital temperature control.

## Colour

Black.

Model	Capacity (L)	Height (mm)	Diameter (mm)	Weight (kg)	Reheat (mins)
QWCd135-480	135	1387	480	22	132
QWCd180-480	180	1761	480	30	175



# EC-EAU

Electric Water Cylinder

## Installation

Floor standing, vertically mounted on flat, level surface.

## IP Rating

IPX1.

## Cable Entry Point

Front, bottom, middle.

## Thermal Cut-out

Manual reset cut-out.

## Element

Immersio heater - 1 3/4" F BSP.  
Titanium optional.

## Construction

22mm stainless steel inner vessel, lightweight, strong and corrosion resistant. HIPS/ABS outer cladding, 60mm CFC/HCFC free injected foam insulation.

## Colour

Black.



73

Model	Capacity (L)	Height (mm)	Diameter (mm)	T&P Valve (mm)	Imm. (mm)	Imm. 2 (mm)	Weight (kg)	Reheat (mins)
ECSd100-580	100	810	580	580	208	-	20	88
ECSd125-580	125	960	580	730	208	570	23	122
ECSd150-580	150	1130	580	900	208	650	26	150
ECSd175-580	175	1280	580	1050	208	750	29	199
ECSd1210-580	210	1504	580	1275	208	820	33	218
ECSd250-580	250	1780	580	1550	208	1265	39	284
ECSd300-580	300	2080	580	1850	208	1495	46	313

Indirect table available at [www.dimplex.co.uk/waterheating](http://www.dimplex.co.uk/waterheating)

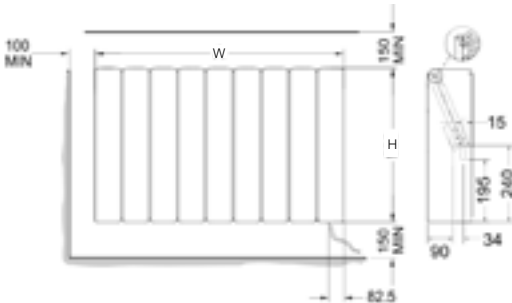

### Installation

Horizontal wall mounting via supplied mounting bracket.

### IP Rating

IPX0.

### Cable Entry Point

Bottom Right. 1m cable length.

### Thermal Cut-out

N/A

### Heat Exchanger

Aluminium finned heat exchange with copper tube.

### Construction

Durable epoxy-polyester powder coated steel casing, with upward facing grille. Temperature resistant PBT thermoplastic moulded parts.

### Colour

White metal/glass.

Model	Finish	Input L/M/B* (W)	Height (mm)	Width (mm)	Depth (mm)	Weight (kg)	AirFlow L/M/B* (m³/h)
SRX080M	Metal	17 / 20 / 27	530	503	145	13	60 / 125 / 228
SRX080WG	Glass	17 / 20 / 27	530	503	145	13	60 / 125 / 228
SRX120M	Metal	22 / 32 / 47	530	670	145	16	100 / 190 / 345
SRX120WG	Glass	22 / 32 / 47	530	670	145	16	100 / 190 / 345
SRX140M	Metal	26 / 40 / 60	530	740	145	18	120 / 225 / 410
SRX140WG	Glass	26 / 40 / 60	530	740	145	18	120 / 225 / 410
SRX180M	Metal	24 / 35 / 53	530	911	145	23	160 / 300 / 540
SRX180WG	Glass	24 / 35 / 53	530	911	145	23	160 / 300 / 540

# Free-E

Photovoltaic Optimiser

## Installation

Mounted to the wall near meter and cylinder. Wireless communicating.

## Construction

Flame retardant polycarbonate case with steel backing plate.

## Colour

White.

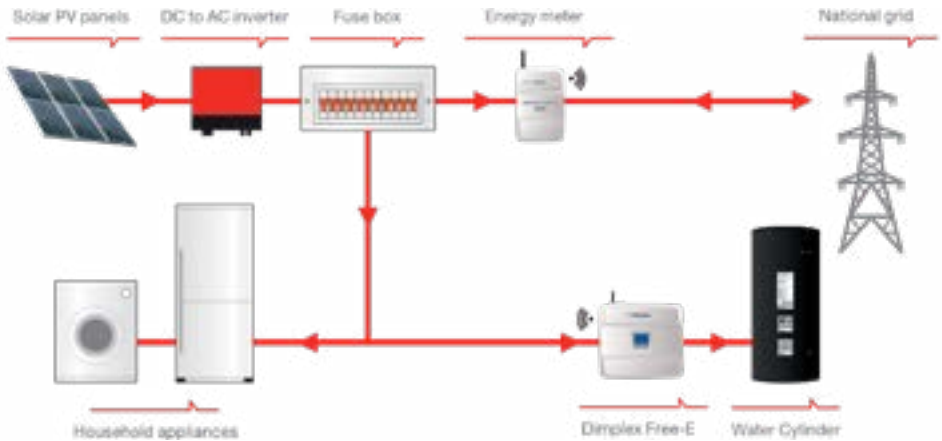

Component	Length (mm)	Width (mm)	Height (mm)	Weight (kg)
Free-E	348	316	121	3.7
Energy Meter	230.8	125	48	0.201

Note: Both units come in the box

## Heater Sizing Tables

These tables provide heater-sizing guidance for traditional electric heating systems, including Quantum, storage heaters and panel heaters.

For single properties please complete a heat design form (page 79) and send it with a sketch plan to our heating design department. We aim to provide this accurate assessment within seven working days. For multiple properties, please send us comprehensive scale drawings (scale 1:50 or 1:100) together with construction details and any other relevant information. We offer a fourteen working day service for this type of assessment.

### Living or dining room: Quantum off-peak heaters are recommended

Heater loading in kW. Temperature 21°C

Floor area	Solid walls			Cavity walls			Insulated cavity walls		
	No. of outside walls			No. of outside walls			No. of outside walls		
m <sup>2</sup>	1	2	3	1	2	3	1	2	3
12	1.84	2.16	2.88	1.60	1.92	2.48	1.12	1.28	1.68
16	2.08	2.48	3.20	1.84	2.32	2.88	1.36	1.60	1.92
20	2.64	3.12	3.92	2.32	2.72	3.44	1.68	1.92	2.32
24	2.96	3.44	4.32	2.64	3.12	3.76	2.08	2.32	2.64
28	3.28	3.92	4.80	2.96	3.44	4.24	2.16	2.48	2.96
32	3.52	4.32	5.28	3.28	3.76	4.72	2.40	2.72	3.20

For XLN heaters, multiply load by 2, for CXLS multiply by 1.25

### Bedrooms: panel heaters are recommended

Heater loading in kW. Temperature 18°C

Floor area	Solid walls			Cavity walls			Insulated cavity walls		
	No. of outside walls			No. of outside walls			No. of outside walls		
m <sup>2</sup>	1	2	3	1	2	3	1	2	3
8	0.8	1.3	1.7	0.8	1.0	1.4	0.8	0.9	1.4
12	0.9	1.8	2.3	0.9	1.4	2.1	0.8	1.4	1.8
16	1.2	2.1	2.7	1.0	1.7	2.2	0.9	1.6	2.1
20	1.4	2.2	3.1	1.2	2.0	2.6	1.0	1.8	2.4
24	1.5	2.3	3.4	1.2	2.1	2.9	1.0	1.9	2.5

For XLS heaters, multiply loading by 1.5

Kitchen									
Heater loading in kW. Temperature 18°C									
Floor area	Solid walls			Cavity walls			Insulated cavity walls		
	No. of outside walls			No. of outside walls			No. of outside walls		
m <sup>2</sup>	1	2	3	1	2	3	1	2	3
10	1.28	1.68	2.32	1.12	1.60	1.92	For all kitchens with cavity wall insulation, direct heating is preferred		
12	1.52	2.16	2.64	1.36	1.84	2.32			
14	1.68	2.40	2.88	1.60	2.08	2.48			
16	1.92	2.64	3.12	1.68	2.32	2.72			

For XLN heaters, multiply load by 2, for CXLS multiply by 1.25

Commercial heating: Quantum off-peak heaters are recommended. Sizing is based on a single storey with a ceiling height of 3m and a minimum of 75mm of roof insulation.

Office									
Heater loading in kW. Temperature 21°C									
Floor area	Solid walls			Cavity walls			Insulated cavity walls		
	No. of outside walls			no. of outside walls			no. of outside walls		
m <sup>2</sup>	1	2	3	1	2	3	1	2	3
15	2.16	2.96	4.08	2.00	2.56	3.52	1.68	2.08	2.64
20	2.64	3.52	4.48	2.40	3.12	4.00	2.08	2.56	3.12
25	2.96	4.08	5.20	2.72	3.68	4.56	2.40	3.04	3.60
30	3.52	4.72	5.84	3.36	4.24	5.20	2.88	3.52	4.16
40	4.80	5.92	7.68	4.40	5.36	6.72	3.92	4.48	5.36
50	5.28	6.80	8.40	4.96	6.24	7.44	4.48	5.28	6.08

For XLS heaters, multiply load by 2, for CXLS multiply by 1.25



# Heating Design Request Form

Complete and return to:  
 Millbrook house, Grange Drive, Hedge End, Southampton. SO30 2DF  
 Fax No: 01489 773067 | Email: heat.design@dimplex.co.uk  
 Alternatively complete online at [www.dimplex.co.uk/heatdesign](http://www.dimplex.co.uk/heatdesign)

Customer name and address (please note: we are unable to complete the scheme unless full name and address details are included)

Contact Name: \_\_\_\_\_ Co. Name: \_\_\_\_\_

Address: \_\_\_\_\_

Postcode: \_\_\_\_\_

Email: \_\_\_\_\_ Tel: \_\_\_\_\_ Fax: \_\_\_\_\_

Site name and address

\_\_\_\_\_  
 \_\_\_\_\_

Type of property (for a flat, please tick 'semi-detached' unless there are other flats on both sides, in which case tick 'terrace')

House  Bungalow  Flat  Detached  Semi-detached  Terraced  Other (please specify): \_\_\_\_\_

Type of construction (tick where appropriate)

Cavity wall	<input type="checkbox"/> Yes <input type="checkbox"/> No	Roof	<input type="checkbox"/> Pitched <input type="checkbox"/> Flat
With insulation	<input type="checkbox"/> Yes <input type="checkbox"/> No	Insulation	<input type="checkbox"/> None <input type="checkbox"/> 100mm <input type="checkbox"/> 150mm <input type="checkbox"/> 200mm
Solid walls	<input type="checkbox"/> Yes <input type="checkbox"/> No	Glazing	<input type="checkbox"/> Single <input type="checkbox"/> Double
Floor	<input type="checkbox"/> Yes <input type="checkbox"/> No	Approximate age of property: _____	

Products to be specified (tick where appropriate)

Please list below the product ranges you would like us to base the scheme on. Alternatively, leave blank and we will match the right products to your property.

Would you like us to include: \_\_\_\_\_

Water Heating  Yes  No

Type of room (e.g. Living/bedroom)	Area (m <sup>2</sup> )	Floor-to-ceiling height	External wall length	Window area (m <sup>2</sup> )	External door area (m <sup>2</sup> )	length to unheated areas	Is room above heated?	Roof above?	Open fireplace?
------------------------------------	------------------------	-------------------------	----------------------	-------------------------------	--------------------------------------	--------------------------	-----------------------	-------------	-----------------

--	--	--	--	--	--	--	--	--	--

--	--	--	--	--	--	--	--	--	--

--	--	--	--	--	--	--	--	--	--

--	--	--	--	--	--	--	--	--	--





# Heating Design Request Form

Complete and return to:  
 Millbrook house, Grange Drive, Hedge End, Southampton. SO30 2DF  
 Fax No: 01489 773067 | Email: heat.design@dimplex.co.uk  
 Alternatively complete online at [www.dimplex.co.uk/heatdesign](http://www.dimplex.co.uk/heatdesign)

Customer name and address (please note: we are unable to complete the scheme unless full name and address details are included)

Contact Name: \_\_\_\_\_ Co. Name: \_\_\_\_\_

Address: \_\_\_\_\_

Postcode: \_\_\_\_\_

Email: \_\_\_\_\_ Tel: \_\_\_\_\_ Fax: \_\_\_\_\_

Site name and address

\_\_\_\_\_  
 \_\_\_\_\_

Type of property (for a flat, please tick 'semi-detached' unless there are other flats on both sides, in which case tick 'terrace')

House  Bungalow  Flat  Detached  Semi-detached  Terraced  Other (please specify): \_\_\_\_\_

Type of construction (tick where appropriate)

Cavity wall	<input type="checkbox"/> Yes <input type="checkbox"/> No	Roof	<input type="checkbox"/> Pitched <input type="checkbox"/> Flat
With insulation	<input type="checkbox"/> Yes <input type="checkbox"/> No	Insulation	<input type="checkbox"/> None <input type="checkbox"/> 100mm <input type="checkbox"/> 150mm <input type="checkbox"/> 200mm
Solid walls	<input type="checkbox"/> Yes <input type="checkbox"/> No	Glazing	<input type="checkbox"/> Single <input type="checkbox"/> Double
Floor	<input type="checkbox"/> Yes <input type="checkbox"/> No	Approximate age of property: _____	

Products to be specified (tick where appropriate)

Please list below the product ranges you would like us to base the scheme on. Alternatively, leave blank and we will match the right products to your property.

Would you like us to include: \_\_\_\_\_

Water Heating  Yes  No

Type of room (e.g. Living/bedroom)	Area (m <sup>2</sup> )	Floor-to-ceiling height	External wall length	Window area (m <sup>2</sup> )	External door area (m <sup>2</sup> )	length to unheated areas	Is room above heated?	Roof above?	Open fireplace?
------------------------------------	------------------------	-------------------------	----------------------	-------------------------------	--------------------------------------	--------------------------	-----------------------	-------------	-----------------

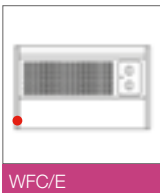
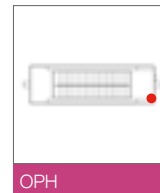
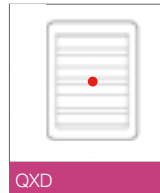
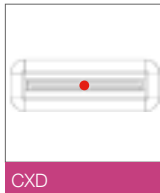
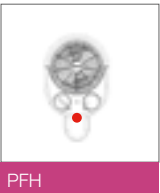
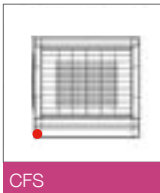
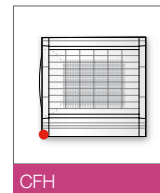
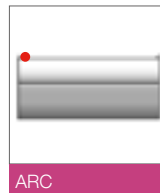
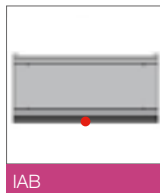
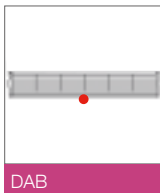
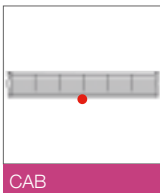
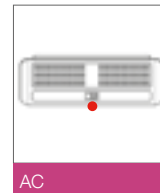
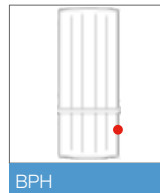
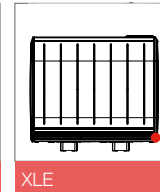
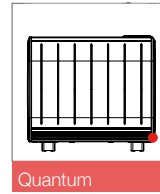
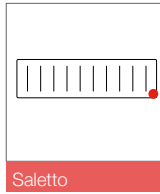
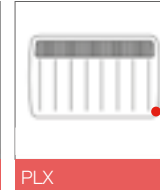
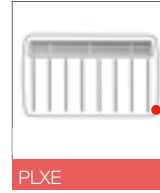
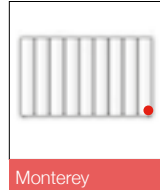
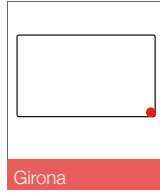
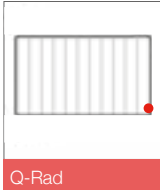

## Bathrooms

Any electrical appliances installed in a bathroom should be fitted by a competent electrician in accordance with the current I.E.E. Regulations.

## Safety

Dimplex products are designed to comply with the requirement of EN60335 part 1 of the British Standard covering the safety requirements of electric heating appliances, and momentary contact with any part of the heater should not cause injury. However, in order to be effective, heaters or towel rails of any type do get hot especially (if applicable) around the air outlet grille. Therefore if aged or infirm persons, or young children, are likely to be unsupervised in the vicinity of a heater we advise precautions should be taken. We recommend a guard is fitted around the heater, as is normal with many types of heating appliance in similar circumstances, to ensure contact with the heater is avoided and objects cannot be inserted into the product. Heating appliances should never be covered or positioned where objects may fall onto them.

## Plugs

All portable appliances are supplied with a fitted plug. We do not recommend using an extension lead with our products.

## Specifications

Dimplex policy is one of continuous improvement; we reserve the right to alter specifications without notice. Although every care has been taken in the reproduction of product finishes in this brochure, the colour photographs should be taken only as a guide. The information contained in this brochure is correct at the time of printing. You are advised to consult your dealer before purchasing.

## Installation Guidance

This brochure is not intended as an installation guide. For safety, products should only be installed by a competent person, in accordance with current regulations and the manufacturers instructions. Please note that the dimensions contained within this brochure do not in all cases include clearances required around installed products for safe operation.

## The Dimplex Range

Dimplex offers the widest range of electric space heating solutions in the UK. In addition to this publication, we have a number of more focused brochures as shown below. These can be ordered via our website. [www.dimplex.co.uk](http://www.dimplex.co.uk)

To find out more about how our team can help you to specify compliant, efficient and intelligent heating solutions, contact us on:

Web: [www.dimplex.co.uk](http://www.dimplex.co.uk)  
Email: [pre-sales@glendimplex.com](mailto:pre-sales@glendimplex.com)  
Call: 0800 028 6122

Ireland enquiries: Glen Dimplex Ireland, tel: 00 353 (1) 8424 277 email: [salesireland@glendimplex.com](mailto:salesireland@glendimplex.com)  
or web: [www.glendimplexireland.com](http://www.glendimplexireland.com)

# Dimplex®



FSC Logo  
to be placed here  
by the printer

Dimplex is a Glen Dimplex Heating & Ventilation brand. Millbrook House, Grange Drive, Hedge End, Southampton SO30 2DF

All the products shown in this brochure are protected by intellectual property rights own by members of the Glen Dimplex Group on an international basis. The Glen Dimplex group of Companies will actively protect these rights.

Products within the Quantum range are protected by one or more of the following patents and patent applications:  
Great Britain GB2481048, GB 2487147, GB 2487148, GB 1101971.8,  
GB 1205302.1, GB 1212547.2, GB1212546.4, GB 1304025.8  
Australia AU 2011263698, Canada CA 2,801,973, Chile CL 03468-2012,  
European EP 11731283.4, New Zealand NZ 604163,  
South Africa ZA 2012/09378, United States US 13/703,068,  
China CN 201180037404.2, Japan JP 506280052

© Dimplex. All rights reserved. Material contained in this publication may not be produced in whole or in part without prior permission in writing.